

ACH580

Installation, Operation and Maintenance Manual (I, O & M)
ACH580-01 HVAC Drives (0.75...250 kW, 1...350 HP)
ACH580-BCR/BDR/VCR/VDR E-Clipse Bypass Drives
(0.75...150 kW, 1...200 HP)
ACH580-PCR/PDR Packaged Drives with Disconnect
(0.75...150 kW, 1...200 HP)



ABB



Safety instructions

These are the safety instructions which you must obey when you install and operate the drive and do maintenance on the drive. If you ignore the safety instructions, injury, death or damage can occur.

Use of warnings and notes in this manual

Warnings tell you about conditions which can cause injury or death, or damage to the equipment. They also tell you how to prevent the danger. Notes draw attention to a particular condition or fact, or give information on a subject.

The manual uses these warning symbols:

	Electricity warning tells about hazards from electricity which can cause injury or death, or damage to the equipment.
	General warning tells about conditions, other than those caused by electricity, which can cause injury or death, or damage to the equipment.
	Electrostatic sensitive devices warning tells you about the risk of electrostatic discharge which can cause damage to the equipment.

General safety in installation, start-up and maintenance

These instructions are for all personnel that install the drive and do maintenance work on it.

 **WARNING!** Obey these instructions. If you ignore them, injury or death, or damage to the equipment can occur.

- Use safety shoes with a metal toe cap to avoid foot injury. Wear protective gloves and long sleeves. Some parts have sharp edges.

- Handle the drive carefully.
 - Frames R5...R9: Lift the drive with a lifting device. Use the lifting eyes of the drive.
 - Frames R5...R9: Do not tip the drive over. The drive is heavy and its center of gravity is high. An overturning drive can cause physical injury.



- Beware of hot surfaces. Some parts, such as heatsinks of power semiconductors, remain hot for a while after disconnection of the electrical supply.
- Keep the drive in its package or protect it otherwise from dust and burr from drilling and grinding until you install it.
- Vacuum clean the area below the drive before the start-up to prevent the drive cooling fan from drawing the dust inside the drive.
- Do not cover the air inlet and outlet when the drive runs.
- Make sure that there is sufficient cooling. See the *ACH580 Hardware Manual* (3AXD50000044839) for more information.

- Before you connect voltage to the drive, make sure that the drive covers are on. Keep the covers on during the operation.
- Before you adjust the drive operation limits, make sure that the motor and all driven equipment can operate throughout the set operation limits.
- Before you activate the automatic fault reset or automatic restart functions of the drive control program, make sure that no dangerous situations can occur. These functions reset the drive automatically and continue operation after a fault or supply break. If these functions are activated, the installation must be clearly marked as defined in IEC/EN 61800-5-1, subclause 6.5.3, for example, "THIS MACHINE STARTS AUTOMATICALLY".
- The maximum number of drive power-ups is five in ten minutes. Too frequent power-ups can damage the charging circuit of the DC capacitors.
- If you have connected safety circuits to the drive (for example, emergency stop and Safe torque off), validate them at the start up. For the validation of the Safe torque off, see ACH580 HVAC control program firmware manual (3AXD50000027537 [English]). For the validation of other safety circuits, see the instructions provided with them.

Note:

- If you select an external source for start command and it is on, and the start command is level-triggered, the drive will start immediately after fault reset. See parameters 20.02 Ext1 start trigger type and 20.07 Ext2 start trigger type in ACH580 HVAC control program firmware manual (3AXD50000027537 [English]).
 - When the control location is not set to Local (text Hand is not shown on the top row of the panel and parameter 19.19 Off mode disable has value Off button disabled), the stop key on the control panel will not stop the drive.
- Frames R1...R5: Do not attempt to repair a malfunctioning drive; contact your local representative for replacement or repair by authorized persons.
 - Frames R6...R9: Can be repaired by authorized persons.

Electrical safety in installation, start-up and maintenance

Precautions before electrical work

These warnings are for all personnel who do work on the drive, motor cable or motor.

 **WARNING!** Frames R1 ... R9: Obey these instructions. If you ignore them, injury or death, or damage to the equipment can occur. If you are not a qualified electrical professional, do not do electrical installation or maintenance work. Go through these steps before you begin any installation or maintenance work.

1. Clearly identify the work location.
2. Disconnect all possible voltage sources. Lock and tag.
 - Open the main disconnect at the power supply of the drive.
 - Make sure that reconnection is not possible.
 - Disconnect any external power sources from the control circuits.
 - After you disconnect the drive, always wait for 5 minutes to let the intermediate circuit capacitors discharge before you continue.
3. Protect any other energized parts in the work location against contact.
4. Take special precautions when close to bare conductors.
5. Measure that the installation is de-energized.
 - Use a multimeter with an impedance of at least 1 Mohm.

- Make sure that the voltage between the drive input power terminals (L1, L2, L3) and the grounding terminal (PE) is close to 0 V.

Frames R1...R3: Measure the voltage between the drive UDC+ terminal and grounding terminal (PE) with one multimeter. As there is no UDC- terminal, measure the voltage between the drive T1/U terminal and grounding terminal (PE) with another multimeter. Make sure that the voltage difference between the multimeters is close to 0 V.

Frames R4...R9: Measure the voltage between the drive DC terminals (UDC+ and UDC-) and the grounding terminal (PE) and make sure that it is close to 0 V.

6. Install temporary grounding as required by the local regulations.
7. Ask for a permit to work from the person in control of the electrical installation work.

If the drive does not operate according to these steps, refer to the *ACH580-01 Hardware Manual* (3AXD50000044839).

Additional instructions and notes



WARNING! Obey these instructions. If you ignore them, injury or death, or damage to the equipment can occur.

- If the drive will be connected on an IT system (ungrounded or high-resistance-grounded [over 30 ohms]), make sure neither the EMC filter nor the ground-to-phase varistor are connected (metal screws should not be installed). Connections with metal screws in these systems can cause danger or damage. See section [Checking the compatibility with IT \(ungrounded\) and corner-grounded TN systems \(North America\)](#) on page 17.

Note: For other systems, connecting the internal EMC filter will reduce the conducted emission.

- If the drive will be connected on a corner-grounded TN system, make sure the EMC filter is not connected (metal screws should

not be installed). Connections with metal screws in these systems can cause danger or damage. See section [Checking the compatibility with IT \(ungrounded\) and corner-grounded TN systems \(North America\)](#) on page 17.

Note: For other systems, connecting the internal EMC filter (using metal screws) will reduce the conducted emission.

- Use all ELV (extra low voltage) circuits connected to the drive only within a zone of equipotential bonding, that is, within a zone where all simultaneously accessible conductive parts are electrically connected to prevent hazardous voltages appearing between them. You can accomplish this by a proper factory grounding, that is, make sure that all simultaneously accessible conductive parts are grounded to the protective earth (PE) bus of the building.
- Do not do insulation or voltage withstand tests on the drive or drive modules.

Note:

- The motor cable terminals of the drive are at a dangerous voltage when the input power is on, regardless of whether the motor is running or not.
- The DC and brake resistor terminals (UDC+, UDC-, R+ and R-) are at a dangerous voltage.
- External wiring can supply dangerous voltages to the terminals of relay outputs (RO1, RO2 and RO3).
- The Safe torque off function does not remove the voltage from the main and auxiliary circuits. The function is not effective against deliberate sabotage or misuse.



WARNING! Use a grounding wrist band when you handle the printed circuit boards. Do not touch the boards unnecessarily. The boards contain components sensitive to electrostatic discharge.

Grounding

These instructions are for all personnel who are responsible for the electrical installation, including the grounding of the drive.

 **WARNING!** Obey these instructions. If you ignore them, injury or death, or equipment malfunction can occur, and electromagnetic interference can increase.

- If you are not a qualified electrical professional, do not do grounding work.
- Always ground the drive, the motor and adjoining equipment to the protective earth (PE) bus of the power supply. This is necessary for the personnel safety. Proper grounding also reduces electromagnetic emission and interference.
- In a multiple-drive installation, connect each drive separately to the protective earth (PE) bus of the power supply.
- Make sure that the conductivity of the protective earth (PE) conductors is sufficient. See section [Power cable terminal and lead-through data](#) on page 19. Obey the local regulations.
- Connect the power cable shields to the protective earth (PE) terminals of the drive.
- Standard IEC/EN & UL 61800-5-1 (section 4.3.5.5.2.) requires that as the normal touch current of the drive is higher than 3.5 mA AC or 10 mA DC, you must use a fixed protective earth (PE) connection. In addition,
 - install a second protective earth conductor of the same cross-sectional area as the original protective earthing conductor,
 or
 - install a protective earth conductor with a cross-section of at least 7 AWG (10 mm²) Cu,
 or
 - install a device which automatically disconnects the supply if the protective earth conductor breaks.

Additional instructions for Safety Functions

 **WARNING!** Bypass configurations (ACH580-VxR & ACH580-BxR) do not support Safe Torque Off (STO) functionality in bypass mode.

Additional instructions for permanent magnet motor drives

Safety in installation, start-up and maintenance

These are additional warnings concerning permanent magnet motor drives. The other safety instructions in this chapter are also valid.

 **WARNING!** Obey these instructions. If you ignore them, injury or death and damage to the equipment can occur.

- Do not work on a drive when a rotating permanent magnet motor is connected to it. A rotating permanent magnet motor energizes the drive including its power terminals.

Before installation, start-up and maintenance work on the drive:

- Stop the motor.
- Disconnect the motor from the drive with a safety switch or by other means.
- If you cannot disconnect the motor, make sure that the motor cannot rotate during work. Make sure that no other system, like hydraulic crawling drives, can rotate the motor directly or through any mechanical connection like felt, nip, rope, etc.
- Measure that the installation is de-energized.
 - Use a multimeter with an impedance of at least 1 Mohm.
 - Make sure that the voltage between the drive output terminals (T1/U, T2/V, T3/W) and the grounding (PE) busbar is close to 0 V.
 - Make sure that the voltage between the drive input power terminals (L1, L2, L3) and the grounding (PE) busbar is close to 0 V.
 - Make sure that the voltage between the drive DC terminals (UDC+, UDC-) and the grounding (PE) terminal is close to 0 V.

- Install temporary grounding to the drive output terminals (T1/U, T2/V, T3/W). Connect the output terminals together as well as to the PE.

Start-up and operation:

- Make sure the motor is not run over the rated speed with dynamic/positive displacement loads.

General safety in operation

These instructions are for all personnel that operate the drive.

 **WARNING!** Obey these instructions. If you ignore them, injury or death, or damage to the equipment can occur.

- Do not control the motor with the line side disconnect at the drive power supply; instead, use the control panel start and stop keys or commands through the I/O terminals of the drive.
- Give a stop command to the drive before you reset a fault. If you have an external source for the start command and the start is on, the drive will start immediately after the fault reset, unless you configure the drive for pulse start. See the firmware manual.
- Before you activate automatic fault reset functions of the drive control program, make sure that no dangerous situations can occur. These functions reset the drive automatically and continue operation after a fault.

Note: When the drive is not in the Hand mode, the Off key on the control panel will not stop the drive.

Cybersecurity disclaimer

This product is designed to be connected to and to communicate information and data via a network interface. It is Customer's sole responsibility to provide and continuously ensure a secure connection between the product and Customer network or any other network (as the case may be). Customer shall

establish and maintain any appropriate measures (such as but not limited to the installation of firewalls, application of authentication measures, encryption of data, installation of anti-virus programs, etc) to protect the product, the network, its system and the interface against any kind of security breaches, unauthorized access, interference, intrusion, leakage and/or theft of data or information. ABB and its affiliates are not liable for damages and/or losses related to such security breaches, any unauthorized access, interference, intrusion, leakage and/or theft of data or information.

Contents

This manual is the Installation, Operation and Maintenance Manual for the ACH580 Drives. Complete technical details are available in the [ACH580 Hardware manual](#), publication number [3AXD50000044839](#). Complete programming information is available in the [ACH580 HVAC control program firmware manual](#), publication number [3AXD50000027537](#).

1. To determine the type of your drive, refer to its construction code on either:

- Serial number label attached on upper part of the top mounting plate between the mounting holes.
- Type code label attached to the base frame – on the side of the enclosure.

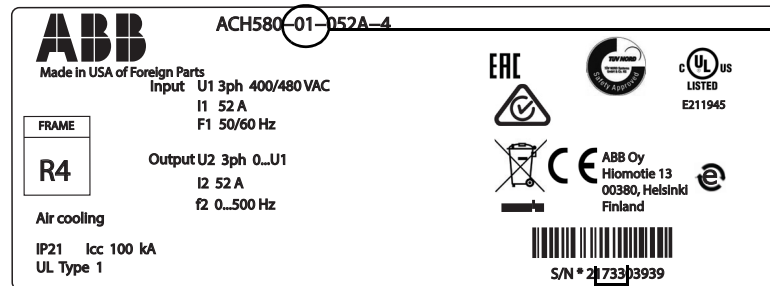
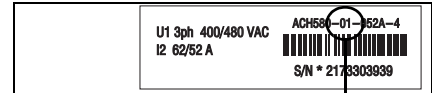

Construction code

Manufacturing year and week

2. According to the construction code, proceed to your drive's installation, operation, diagnostics and maintenance information:

- 01 (Wall-Mounted Single Drives) – Below.
- VCR, VDR, BCR, BDR (E-Clipse Bypass) – page [89](#).
- PCR, PDR (Packaged Drives with Disconnect) – page [135](#).

ACH580-01 Installation

Installation

Study these installation instructions carefully before proceeding. **Failure to observe the warnings and instructions may cause a malfunction or personal hazard.**



WARNING! Before you begin read [Safety instructions](#) on page 2.

1. Check free space requirements

The drive must be installed on the wall. There are two alternative ways to install it.

Note: Do not install upside down.

Vertically alone

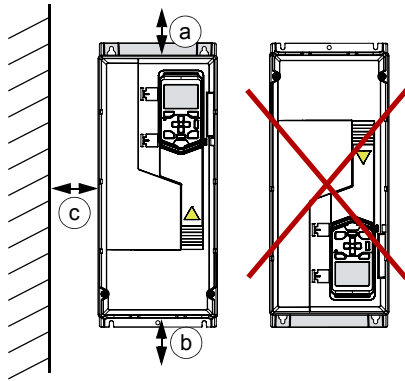

Frame size	Vertical installation - Free space					
	Above (a) ¹⁾		Below (b) ²⁾		Beside (c) ³⁾	
	mm	in	mm	in	mm	in
R1	200	7.87	150	5.91	150	5.91
R2	200	7.87	150	5.91	150	5.91
R3	200	7.87	200	7.87	150	5.91
R4	53	2.09	200	7.87	150	5.91
R5	100	3.94	200	7.87	150	5.91
R6	155	6.10	300	11.81	150	5.91
R7	155	6.10	300	11.81	150	5.91
R8	155	6.10	300	11.81	150	5.91
R9	200	7.87	300	11.81	150	5.91

3AXD00000586715.xls K

1) Free space above is measured from the frame, not from the hood used in UL (NEMA) Type 12 frames.

Note: The height of the hood for frames R4 and R9 exceeds the requirement of free space above for these frames..

Frame size	R4	R9
Hood height (in)	2.83	9.06
Hood height (mm)	72	230

2) Free space below is measured from the frame, not from the cable box used in frames R1...R2 and R5...R9.

3) Free space between the drive and other objects, e.g. wall.

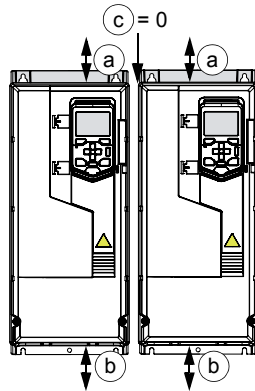
Vertically side by side

Frame size	Vertical installation side by side - Free space					
	Above (a)		Below (b) ¹⁾		Between (c)	
	mm	in.	mm	in.	mm	in.
R1 ²⁾	200	7.87	200	7.87	0	0
R2 ²⁾	200	7.87	200	7.87	0	0
R3 ²⁾	200	7.87	200	7.87	0	0
R4	200	7.87	200	7.87	0	0
R5	200	7.87	200	7.87	0	0
R6	200	7.87	300	11.81	0	0
R7	200	7.87	300	11.81	0	0
R8	200	7.87	300	11.81	0	0
R9	200	7.87	300	11.81	0	0

1) Free space above is measured from the frame, not from the hood used in UL (NEMA) Type 12 frames.

Note: The height of the hood for frames R4 and R9 exceeds the requirement of free space above for these frames.

2) Free space below is always measured from the drive frame, not from the cable box.

2. Prepare for installation

Lifting R1...R4

Lift the drive only by the chassis.

Lifting R5...R8

1. Use a pallet truck to move the transport package/enclosure to the installation site.



WARNING! Frames R5...R9: Lift the drive with a lifting device. Use the lifting eyes of the drive. **The drive is heavy and its center of gravity is high. An overturning drive can cause physical injury.**

2. Use a hoist to lift the drive. (Do not place drive in final position until mounting site is prepared.)

Unpack the drive

1. Unpack the drive.
2. Check for any damage and notify the shipper immediately if damaged components are found.
3. Check the contents against the order and the shipping label to verify that all parts have been received.

Tools required

To install the ACH580 you need the following:

- Screwdrivers as appropriate for the mounting hardware used, including a T20 Torx driver for drive cover removal
- Wire stripper
- Tape measure and/or provided mounting template
- Drill
- Frame sizes R5...R9: pallet truck and hoist
- Frame sizes R5...R9: The appropriate crimping tool for power cable lugs.
- Mounting hardware: screws or nuts and bolts. The type, length and quantity of hardware depends on the mounting surface and the frame size:

Frame size	Mounting hardware		Qty
R1...R2	M5	#10	4
R3	M6	1/4 in.	4
R5	M6	1/4 in.	6
R6...R9	M8	5/16 in.	4



WARNING! Before installing the ACH580, ensure the input power supply to the drive is off.



WARNING! Metal shavings or debris in the enclosure can damage electrical equipment and create a hazardous condition. Where parts, such as conduit plates require cutting or drilling, first remove the part. If that is not practical, cover nearby electrical components to protect them from all shavings or debris.

Flange Mounting

Frame size	Kit
R1	3AXD50000105311
R2	3AXD50000105328
R3	3AXD50000105335
R4	3AXD50000031460
R5	3AXD50000031461
R6	3AXD50000018852
R7	3AXD50000018853
R8	3AXD50000018854
R9	3AXD50000018855

Further information is in *Supplement: Flange mounting kit installation*, 3AXD50000201877.

3. Install the drive

Installing the drive vertically, frames R1...R4

The figures show frame R3 as an example.

1. Mark the hole locations using the mounting template included in the package. Do not leave the mounting template under the drive. The drive dimensions and hole locations are also shown in the drawings in the *ACH580 Hardware manual*, publication number [3AXD5000044839](#).
2. Drill the mounting holes.
3. Insert anchors or plugs into the holes and start the bolts into the anchors or plugs. Use long enough bolts to make them carry the weight of the drive.

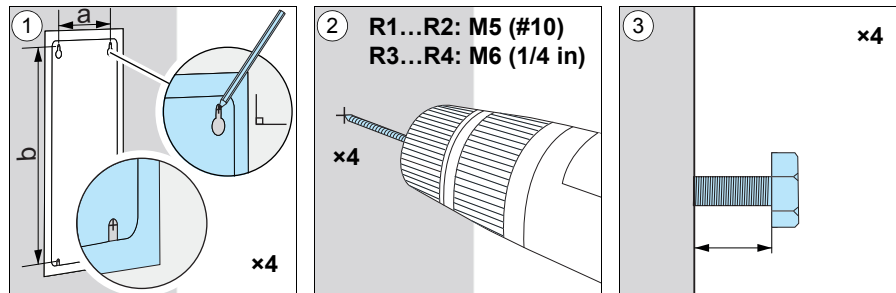

	R1		R2		R3		R4	
	in.	mm	in.	mm	in.	mm	in.	mm
a	3.86	98	3.86	98	6.30	160	6.30	160
b	12.48	317	16.42	417	18.62	473	24.37	619
Weight	lb	kg	lb	kg	lb	kg	lb	kg
IP21 (UL (NEMA) Type 1)	10.1	4.6	14.6	6.6	26.0	11.8	41.9	19.0
Weight	lb	kg	lb	kg	lb	kg	lb	kg
IP55 (UL (NEMA) Type 12)	10.6	4.8	15.0	6.8	28.7	13.0	44.1	20.0

4. Position the drive onto the bolts on the wall.
5. Tighten the bolts in the wall securely.

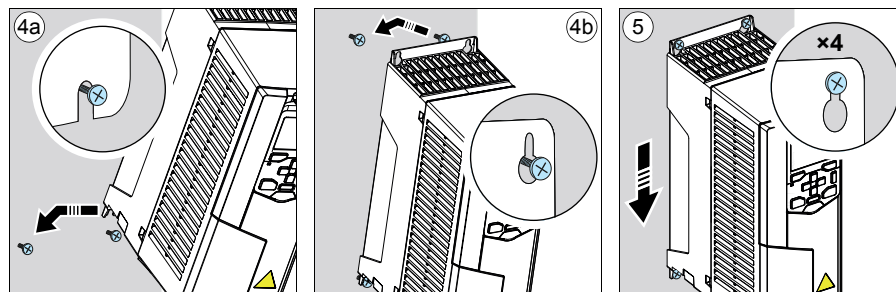

Install the cable box, frames R1...R2

6. Remove the screw (6a) and lift the cover off (6b) from the separate cable box.
7. Attach the cable box cover to the front cover.

- Install the cable box to the frame. Position the cable box (8a) and tighten the screws (8b).

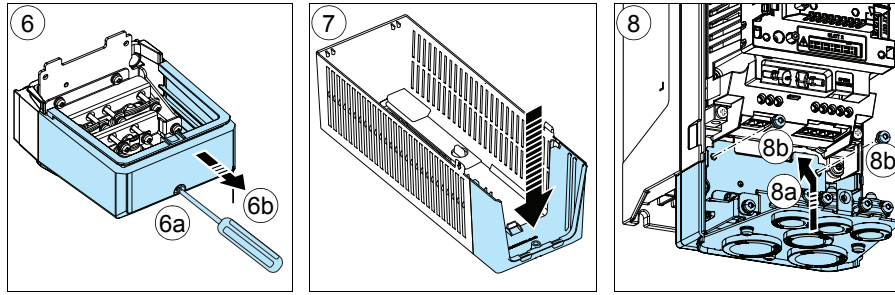

Note: Install the hood to UL (NEMA) Type 12 drives after you have installed the drive electrically and reinstalled covers.

Installing the drive vertically, frame R5

- Mark the hole locations using the mounting template included in the package. Do not leave the mounting template under the drive. The drive dimensions and hole locations are also shown in the drawings in the [ACH580 Hardware manual](#), publication number [3AXD50000044839](#).
- Drill the mounting holes.
- Insert anchors or plugs into the holes. Start the two upper bolts and the two lowest bolts into the anchors or plugs.

Use long enough bolts to make them carry the weight of the drive.

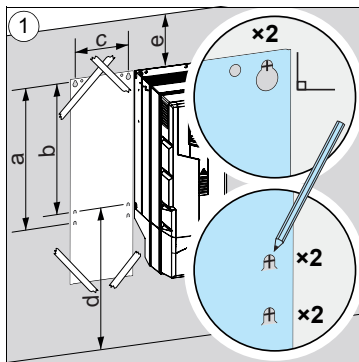

	R5 IP21 (UL (NEMA))		R5 IP55 (UL (NEMA))	
	in.	mm	in.	mm
a	24.09	612	24.09	612
b	22.87	581	22.87	581
c	6.30	160	6.30	160
d >	7.87	200	7.87	200
e >	3.94	100	3.94	100

⚠	R5 IP21 (UL (NEMA))		R5 IP55 (UL (NEMA))	
	lb	kg	lb	kg
	62.4	28.3	64.0	29.0

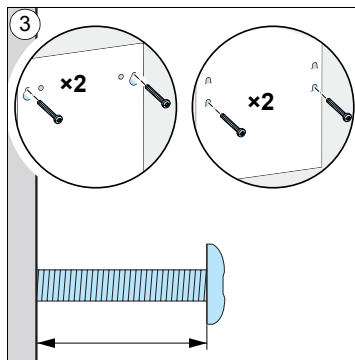
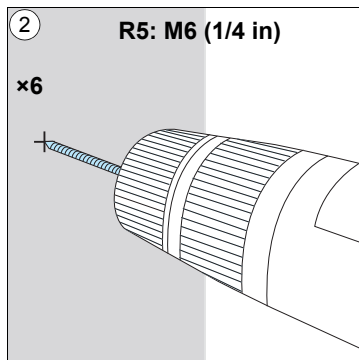

IP21 (UL (NEMA) Type 1)

4. Remove the front cover: Remove the fastening screws (4a) with a T20 Torx screwdriver and lift the cover from the bottom upwards (4b) and then to the top side (4c).
5. Attach the cable box to the drive frame.
6. Tighten the box nuts.
7. Slide the box cover from the bottom (7a) and tighten the retaining screws (7b).
8. Put the tabs at the top of the front cover in their counterparts on the housing and then press at the bottom (8a) and tighten the retaining screws (8b).

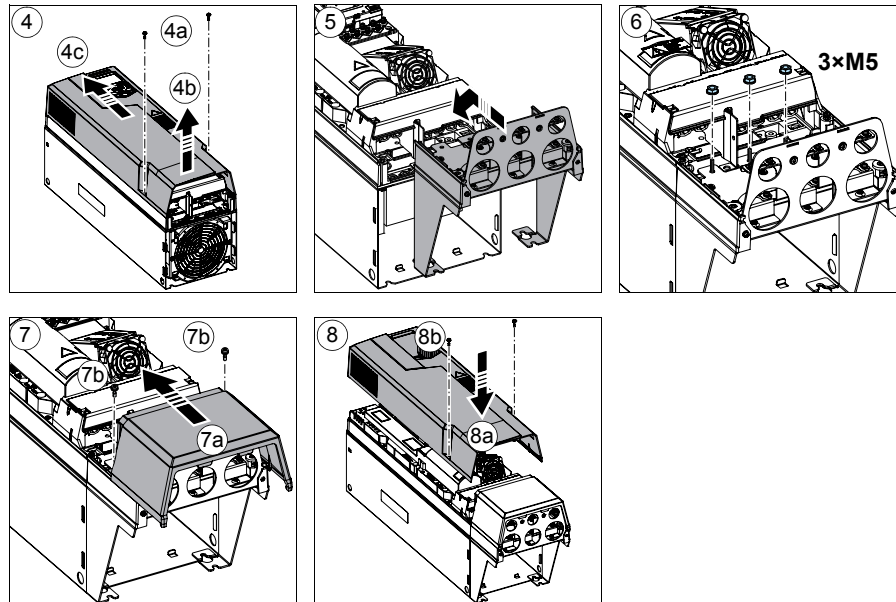
**IP21 (UL (NEMA) Type 1), IP55 (UL (NEMA) Type 12)**

9. Position the drive onto the four bolts on the wall. Lift the drive with another person or with a lifting device as it is heavy. Tighten the bolts in the wall securely.
10. Tighten the two remaining bolts securely.

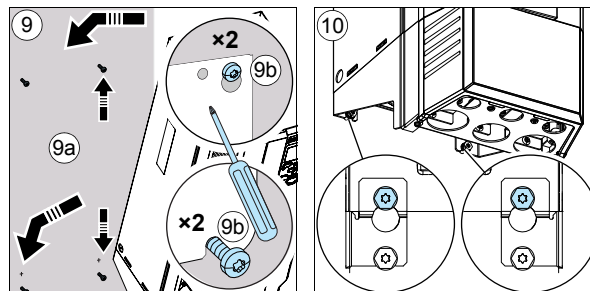

Note: Install the hood on UL (NEMA) Type 12 drives after you have installed the drive electrically and reinstalled covers.

Installing the drive vertically, frames R6...R9

1. Mark the hole locations for the six mounting holes using the mounting template included in the package. Do not leave the mounting template under the drive.

The drive dimensions and hole locations are also shown in the drawings in the [ACH580 Hardware manual](#), publication number [3AXD5000044839](#).

Note: You can use only two bolts instead of four to attach the lower part of the drive.

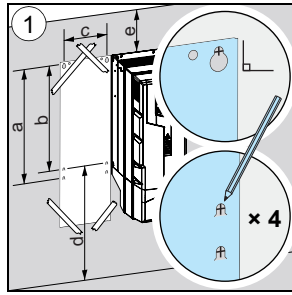

	R6		R7		R8		R9	
	in.	mm	in.	mm	in.	mm.	in.	mm
a	22.5	571	24.5	623	27.6	701	28.3	718
b	20.9	531	23.0	583	25.9	658	25.9	658
c	8.4	213	9.7	245	10.4	263	13.6	345
d	11.8	300	11.8	300	11.8	300	11.8	300
e	6.1	155	6.1	155	6.1	155	7.9	200
IP21, UL (NEMA) Type 1	lb	kg	lb	kg	lb	kg	lb	kg
	93.5	42.4	119.1	54.0	152.2	69.0	213.9	97.0
IP55, UL (NEMA) Type 12	lb	kg	lb	kg	lb	kg	lb	kg
	94.8	43.0	123.5	56.0	169.8	77.0	227.1	103.0

2. Drill the mounting holes.
3. Insert anchors or plugs into the holes and start the bolts into the anchors or plugs.
Use a sufficient number of bolts that are long enough to make them carry the weight of the drive.
4. Position the drive onto the bolts on the wall. Lift the drive with a lifting device with another person as it is heavy.
5. Tighten the top two bolts in the wall securely.

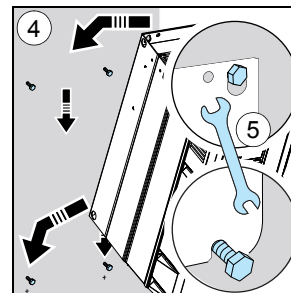
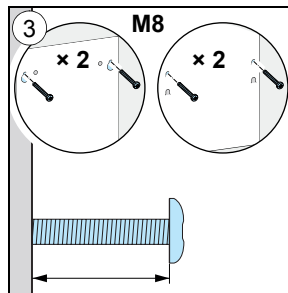
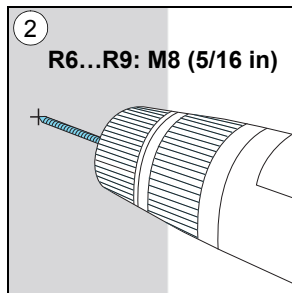

IP21 (UL (NEMA) Type 1)

6. Remove the front cover: Remove the fastening screws (a), with a T20 Torx screwdriver, move the cover to the top side (b) and then up (c).
7. Attach the cable box to the drive frame.
8. Tighten the box bolts: three at the top (8a) and two at the bottom (8b). Also tighten the bottom bolts started in step 3 (8c).

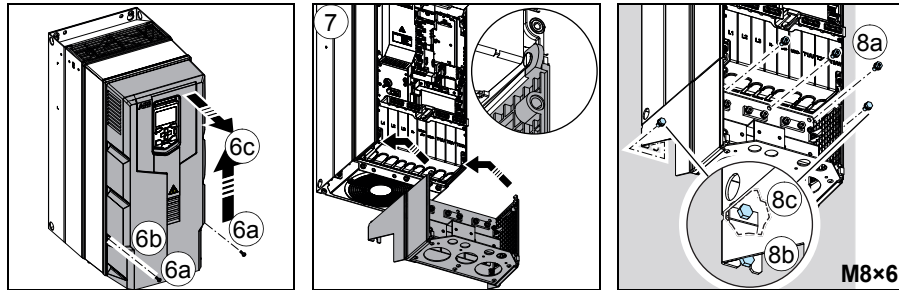
**IP55 (UL (NEMA) Type 12)**

9. Remove the front cover: Remove the fastening screws (a), with a T20 Torx screwdriver, move the cover to the top side (b) and then up (c).

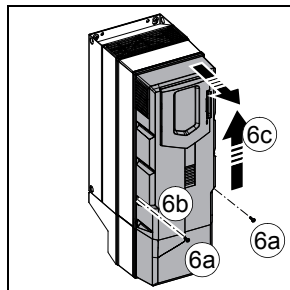

Note: Install the hood on UL (NEMA) Type 12 drives after you have installed the drive electrically and reinstalled covers.

Installing the drive vertically side by side

Install the drive following the steps in the appropriate section [Installing the drive vertically, frames R1...R4](#) (page 11), or [Installing the drive vertically, frame R5](#) (page 12) or [Installing the drive vertically, frames R6...R9](#) (page 14).

4. Install wiring



WARNING! Ensure the motor is compatible for use with the ACH580. The ACH580 must be installed by a competent person. If in doubt, contact your local ABB sales or service office.



WARNING! If the drive will be connected on an IT (ungrounded) system, make sure neither the EMC filter nor the ground-to-phase varistor are connected. If the drive will be connected on a corner-grounded TN system, make sure you have not connected the EMC filter. See [Checking the compatibility with IT \(ungrounded\) and corner-grounded TN systems \(North America\)](#) on page 17.

Checking the insulation of the assembly



WARNING! Do not make any voltage tolerance or insulation resistance tests on any part of the drive as testing can damage the drive. The drive has been tested at the factory.

1. Check the insulation of the input cable according to local regulations before connection to the drive. Minimum cable temperature rating of 167 °F (75 °C) must be used.
2. With the motor cable connected to the motor, but NOT to the drive output terminals T1/U, T2/V and T3/W, measure the insulation resistance between the phase conductors and between each phase conductor and the Protective Earth (PE) conductor, using a measuring voltage of 1000 V DC. The insulation resistance must exceed 100 Mohm at 25 °C.

Ground connections

For personnel safety, proper operation and to reduce electromagnetic emission/pick-up, the drive and the motor must be grounded at the installation site.

- Conductors must be adequately sized as required by safety regulations.
- Power cable shields must be connected to the drive PE terminal in order to meet safety regulations.
- Power cable shields are suitable for use as equipment grounding conductors only when the shield conductors are adequately sized as required by safety regulations.
- In multiple drive installations, do not connect drive terminals in series.

Checking the compatibility with IT (ungrounded) and corner-grounded TN systems (North America)



WARNING! If the drive will be connected on an IT system (ungrounded or high-resistance-grounded [over 30 ohms]), make sure that neither the EMC filter nor the ground-to-phase varistor are connected, that is, the metal screws must not be installed.

If the drive will be connected on a corner-grounded TN system, make sure that the EMC filter is not connected, that is, the metal screws must not be installed.

Connections with metal screws in these systems can cause danger or damage.

EMC filter

The AC and DC EMC filters are not suitable for use on an IT (ungrounded) system or on a corner-grounded TN system. UL (NEC) drives are shipped with a plastic screw installed to disconnect the internal DC EMC (electro-magnetic compatibility) filter. Disconnect the AC EMC filter by removing the metal screw before connecting the drive to the supply network. On symmetrically-grounded TN systems (TN-S) where EMC is a concern, the installed DC EMC plastic screw can be replaced with the provided metal screw to connect the filter. See the table on page 18. EMC screw location(s) are labeled on the drive.

Note: When the internal EMC filter is disconnected, the drive EMC compatibility is considerably reduced.

Ground-to-phase varistor

The ground-to-phase varistor is not suitable for use on an IT (ungrounded) system. Disconnect the ground-to-phase varistor by removing the metal screw before connecting the drive to the supply network. See the table on page 18. The VAR screw location is labeled on the drive.

Check the table below to determine which screws may be metal for your system.

Frame sizes	Screw label	Factory default screw material ¹⁾	Configure the ACH580 EMC Filter based on the electrical system of the installation		
			Symmetrically grounded TN systems (e.g. Center-grounded-wye) ³⁾	Corner grounded TN systems ⁴⁾	IT systems (ungrounded or high-resistance grounded [>30 ohms]) ⁵⁾
R1...R3	EMC (DC)	Plastic	Can install metal screw	Maintain the plastic screw	Maintain the plastic screw.
	VAR	Metal	Maintain the metal screw	Remove the metal screw	Remove the metal screw
R4...R5	EMC (AC)	Plastic	Can install metal screw	Maintain the plastic screw ²⁾	Maintain the plastic screw
	EMC (DC)	Plastic	Can install metal screw	Maintain the plastic screw	Maintain the plastic screw
	VAR	Metal	Maintain the metal screw	Maintain the metal screw ²⁾	Remove the metal screw
R6...R9	EMC (AC)	Plastic	Can install metal screw	Maintain the plastic screw	Maintain the plastic screw
	EMC (DC)	Plastic	Can install metal screw	Maintain the plastic screw	Maintain the plastic screw
	VAR	Metal	Maintain the metal screw	Maintain the metal screw	Remove the metal screw

1) EMC and VAR columns show the screw material when the drive is shipped.

2) R4 and R5 frames were evaluated for use on corner grounded networks by UL standards. R4 and R5 frames are not to be used on IEC installations of corner grounded networks.

3)

4)

5)

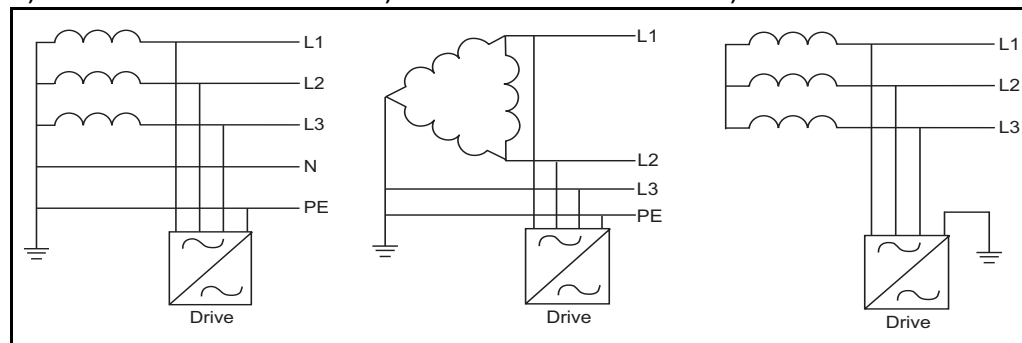

Note: The VAR screw on R1...R3 also connects the EMC (AC) circuit internally within the VFD.

Note: Failure to remove a metal screw, when indicated in the table above, may result in VFD failure.

Note: For statements containing “Maintain plastic screw.”: Metal screw must not be used, plastic screw may be maintained or removed from the AC EMC circuit.

Power cable terminal and lead-through data

Input, motor, resistor and DC cable lead-throughs, maximum wire sizes (per phase) and terminal screw sizes.

Frame size	Cable lead-throughs			L1, L2, L3, T1/U, T2/V, T3/W terminals ¹⁾				Grounding terminals ¹⁾	
	Per cable type	Max cable dia.		Min wire size (solid/stranded)		Max wire size (solid/stranded)		Max wire size	
		pcs	in.	mm	AWG	mm ²	AWG	mm ²	AWG
R1	1	1.18	30	14	2.1	10	6/4	6/6	16/16
R2	1	1.18	30	14	2.1	6	16/16	6/6	16/16
R3	1	1.18	30	14	2.1	2	35/25	2/2	35/35
R4	1	1.77	45	14	2.1	1	50	2/2	35/35
R5	1	1.77	45	14	2.1	2/10	70	2)	2)
R6	1	1.77	45	4	25	300 MCM	150	2)	2)
R7	1	2.13	54	3/0	95	500 MCM	240	2)	2)
R8	2	1.77	45	2×1/0	2×50	2×300 MCM	2×150	2)	2)
R9	2	2.13	54	2×3/0	2×95	2×500 MCM	2×240	2)	2)

1) Screwdrivers: R1 - Slot 4 mm and PH1; R2 - 4.5 mm and PH2; R3, R4 - PH2

2) Either cable lug (R5) or clamp (R6...R9) is used for grounding.

Frame size	Cable lead-throughs			R+, R-, UDC+ and UDC- terminals ¹⁾						
	Per cable type	Max cable dia.		Min wire size (solid/stranded)		Max wire size (solid/stranded)		Hardware	Torque	
		pcs	in.	mm	AWG	mm ²	AWG	mm ²	M...	lb-ft
R1	1	0.906	23	14	2.1	10	6/4	1)	0.4	1.2...1.5
R2	1	0.906	23	14	2.1	6	16/16	1)	1.1	1.2...1.5
R3	1	0.906	23	14	2.1	2	35/25	1)	3.3	2.5...4.5
R4	1	1.54	39	14	2.1	1	50	1)	3.0	4.0
R5	1	1.54	39	14	2.1	2/10	70	M5	4.1	5.6
R6	1	1.77	45	4	25	300 MCM	150	M8	22.1	30
R7	1	2.13	54	3/0	95	500 MCM	240	M10	29.5	30
R8	2	1.77	45	2×1/0	2×50	2×300 MCM	2×150	M10	29.5	40
R9	2	2.13	54	2×3/0	2×95	2×500 MCM	2×240	M12	51.6	70

1) Screwdrivers: R1 - Slot 4 mm and PH1; R2 - 4.5 mm and PH2; R3, R4 - PH2

Note: Minimum wire size does not necessarily have enough current capability for full load. Make sure the installation complies with local laws and regulations.

Maximum recommended motor cable length

Operational functionality and motor cable length

The drive is designed to operate with optimum performance with the following maximum motor cable lengths..

Note: Conducted and radiated emissions of these motor cable lengths do not comply with EMC requirements.

Frame size	Maximum motor cable length, 4 kHz ^{1, 2}			
	Scalar control		Vector control	
	m	ft	m	ft
Standard drive, without external options				
R1	100	330	100	330
R2	200	660	200	660
R3	300	990	300	990
R4	300	990	300	990
R5	300	990	300	990
R6	300	990	300	990
R7	300	990	300	990
R8	300	990	300	990
R9	300	990	300	990

- 1) In multimotor systems, the calculated sum of all motor cable lengths must not exceed the maximum motor cable length given in the table.
- 2) Longer motor cables cause a motor voltage decrease which limits the available motor power. The decrease depends on the motor cable length and characteristics. Contact ABB for more information.

Control cable terminal and lead-through data

Imperial control cable lead-throughs, wire sizes and tightening torques (T) are given below.

Frame size	Cable lead-throughs		Control cable entries and terminal sizes			
	Holes	Max cable size	+24V, DCOM, DGND, EXT. 24V terminals		DI, AI/O, AGND, RO, STO terminals	
			Wire size	T	Wire size	T
	pcs	in.	AWG	lb·ft	AWG	lb·ft
R1	3	0.67	24...14	0.4	26...14	0.4
R2	3	0.67	24...14	0.4	26...14	0.4
R3	3	0.67	24...14	0.4	26...14	0.4
R4	4	0.67	24...14	0.4	26...14	0.4
R5	3	0.67	24...14	0.4	26...14	0.4
R6	4	0.67	26...14	0.4	26...14	0.4
R7	4	0.67	26...14	0.4	26...14	0.4
R8	4	0.67	26...14	0.4	26...14	0.4
R9	4	0.67	26...14	0.4	26...14	0.4

Metric control cable lead-throughs, wire sizes and tightening torques (T) are given below.

Frame size	Cable lead-throughs		Control cable entries and terminal sizes			
	Holes	Max cable size	+24V, DCOM, DGND, EXT. 24V terminals		DI, AI/O, AGND, RO, STO terminals	
			Wire size	T	Wire size	T
	pcs	mm	mm ²	N·m	mm ²	N·m
R1	3	17	0.2...2.5	0.5...0.6	0.14...1.5	0.5...0.6
R2	3	17	0.2...2.5	0.5...0.6	0.14...1.5	0.5...0.6
R3	3	17	0.2...2.5	0.5...0.6	0.14...1.5	0.5...0.6
R4	4	17	0.2...2.5	0.5...0.6	0.14...1.5	0.5...0.6
R5	3	17	0.2...2.5	0.5...0.6	0.14...1.5	0.5...0.6
R6	4	17	0.14...2.5	0.5...0.6	0.14...2.5	0.5...0.6
R7	4	17	0.14...2.5	0.5...0.6	0.14...2.5	0.5...0.6
R8	4	17	0.14...2.5	0.5...0.6	0.14...2.5	0.5...0.6
R9	4	17	0.14...2.5	0.5...0.6	0.14...2.5	0.5...0.6

UL (NEC) ratings at $U_N = 208 \text{ VAC}$

Output Ratings HP	Type	Output ratings	Heat dissipation	Air flow	Frame size
		A	W	ft ³ /min	
3-phase $U_N = 460 \text{ V}$ (380...415 V / 440...480 V) Power ratings are valid at nominal voltage, 460V.					
1	ACH580-01-04A6-2	4.6	45	25	R1
1.5	ACH580-01-06A6-2	6.6	55	25	R1
2	ACH580-01-07A5-2	7.5	66	25	R1
3	ACH580-01-10A6-2	10.6	84	25	R1
5	ACH580-01-017A-2	16.7	133	25	R1
7.5	ACH580-01-024A-2	24.2	174	59	R2
10	ACH580-01-031A-2	30.8	228	59	R2
15	ACH580-01-046A-2	46.2	322	105	R3
20	ACH580-01-059A-2	59.4	430	105	R3
25	ACH580-01-075A-2	74.8	525	170	R4
30	ACH580-01-088A-2	88	619	82	R5
40	ACH580-01-114A-2	114	835	82	R5
50	ACH580-01-143A-2	143	1035	256	R6
60	ACH580-01-169A-2	169	1251	265	R7
75	ACH580-01-211A-2	211	1521	265	R7
100	ACH580-01-273A-2	273	2061	324	R8

UL (NEC) ratings at $U_N = 460 \text{ VAC}$

Output Ratings HP	Type	Output ratings	Heat dissipation	Air flow	Frame size
		A	W	ft ³ /min	
3-phase $U_N = 460 \text{ V}$ (380...415 V / 440...480 V) Power ratings are valid at nominal voltage, 460V.					
1	ACH580-01-02A1-4	2.1	45	25	R1
1.5	ACH580-01-03A0-4	3	55	25	R1
2	ACH580-01-03A5-4	3.5	66	25	R1
3	ACH580-01-04A8-4	4.8	84	25	R1
5	ACH580-01-07A6-4	7.6	133	25	R1
7.5	ACH580-01-012A-4	12	174	25	R1
10	ACH580-01-014A-4	14	228	59	R2
15	ACH580-01-023A-4	23	322	59	R2
20	ACH580-01-027A-4	27	430	105	R3
25	ACH580-01-034A-4	34	525	105	R3
30	ACH580-01-044A-4	44	619	105	R3
40	ACH580-01-052A-4	52	835	79	R4
50	ACH580-01-065A-4	65	1024	79	R4
60	ACH580-01-077A-4	77	1024	79	R4
75	ACH580-01-096A-4	96	1510	82	R5

Output Ratings	Type	Output ratings	Heat dissipation	Air flow	Frame size
HP		A	W	ft ³ /min	
100	ACH580-01-124A-4	124	1476	256	R6
125	ACH580-01-156A-4	156	1976	265	R7
150	ACH580-01-180A-4	180	2346	265	R7
200	ACH580-01-240A-4	240	3336	324	R8
250	ACH580-01-302A-4	302	4836	677	R9
300	ACH580-01-361A-4	361	6036	677	R9
350	ACH580-01-414A-4	414	6036	677	R9

UL (NEC) ratings at $U_N = 575$ VAC

Output Ratings	Type	Output ratings	Heat dissipation	Air flow	Frame size
HP		A	W	ft ³ /min	
3-phase $U_N = 460$ V (380...415 V / 440...480 V)					
Power ratings are valid at nominal voltage, 460V.					
2	ACH580-01-02A7-6	2.7	66	59	R2
3	ACH580-01-03A9-6	3.9	84	59	R2
5	ACH580-01-06A1-6	6.1	133	59	R2
7.5	ACH580-01-09A0-6	9	174	59	R2
10	ACH580-01-011A-6	11	228	59	R2
15	ACH580-01-017A-6	17	322	59	R2
20	ACH580-01-022A-6	22	430	105	R3
25	ACH580-01-027A-6	27	525	105	R3
30	ACH580-01-032A-6	32	619	105	R3
40	ACH580-01-041A-6	41	835	82	R5
50	ACH580-01-052A-6	52	1024	82	R5
60	ACH580-01-062A-6	62	1240	82	R5
75	ACH580-01-077A-6	77	1510	82	R5
100	ACH580-01-099A-6	99	2061	265	R7
125	ACH580-01-125A-6	125	2466	265	R7
150	ACH580-01-144A-6	144	3006	324	R8
200	ACH580-01-192A-6	156	4086	677	R9
250	ACH580-01-242A-6	242	4896	677	R9
250	ACH580-01-271A-6	271	4896	677	R9

Definitions

U_N Output voltage of the drive.

I Continuous rms output current, allowing 110% overload for 1 minute every 10 minutes.

P Typical motor power valid at nominal voltage, 460V.

Fuses

Note: The UL listed fuses in the table are the required branch circuit protection. Fuses are to be provided as part of the installation.

- Fuses are not included in the purchased drive and must be provided by others.
- Fuses with higher current rating than specified must not be used.
- Fuses with lower current rating than specified may be used if they are of the same class and voltage rating. It is the user's responsibility to verify that lower current rated fuses are compliant with local regulations and appropriate for the application.
- Drive fuses must be used to maintain the drive UL listing. Additional protection can be used. Refer to local codes and regulations.

208...240 volt, fuse requirements

ACH580-01-	Input current A	UL			
		Maximum current	Voltage rating	Bussmann type ¹	UL class
		A	V		
3-phase $U_N = 208$ V					
04A6-2	4.6	15	600	KTK-R-15 or JJS-15	CC or T
06A6-2	6.6	15	600	KTK-R-15 or JJS-15	CC or T
07A5-2	7.5	15	600	KTK-R-15 or JJS-15	CC or T
10A6-2	10.6	15	600	KTK-R-15 or JJS-15	CC or T
017A-2	16.7	30	600	KTK-R-30 or JJS-30	CC or T
024A-2	24.2	40	600	JJS-40	T
031A-2	30.8	40	600	JJS-40	T
046A-2	46.2	80	600	JJS-80	T
059A-2	59.4	80	600	JJS-80	T
075A-2	74.8	100	600	JJS-100	T
088A-2	88	150	600	JJS-150	T
114A-2	114	150	600	JJS-150	T
144A-2	143	200	600	JJS-200	T
169A-2	169	250	600	JJS-250	T
211A-2	211	300	600	JJS-300	T
273A-2	273	400	600	JJS-400	T

1) ABB does not require Bussmann brand fuses. Fuses which meet the appropriate UL class type, current rating, and are rated at 600V, 200 kA may be used.

380...480 volt, fuse requirements

ACH580-01-	Input current A	UL			
		Maximum current	Voltage rating	Bussmann type ¹	UL class
		A	V		
3-phase $U_N = 460$ V					
02A1-4	2.1	15	600	JJS-15	T
0340-4	3.0	15	600	JJS-15	T
03A5-4	3.5	15	600	JJS-15	T
04A8-4	4.8	15	600	JJS-15	T
07A6-4	7.6	15	600	JJS-15	T
012A-4	12.0	15	600	JJS-15	T
014A-4	14.0	30	600	JJS-30	T
023A-4	23.0	30	600	JJS-30	T
027A-4	27.0	40	600	JJS-40	T
034A-4	34.0	60	600	JJS-60	T
044A-4	44.0	60	600	JJS-60	T
052A-4	52	80	600	JJS-80	T
065A-4	62	100	600	JJS-100	T
077A-4	77	100	600	JJS-100	T
096A-4	106	150	600	JJS-150	T
124A-4	124	200	600	JJS-200	T
156A-4	156	225	600	JJS-225	T
180A-4	180	300	600	JJS-300	T
240A-4	240	350	600	JJS-350	T
302A-4	302	500	600	JJS-500	T
361A-4	361	500	600	JJS-500	T
414A-4	414	600	600	JJS-600	T

1) ABB does not require Bussmann brand fuses. Fuses which meet the appropriate UL class type, current rating, and are rated at 600V, 200 kA may be used.

500...600 volt, fuse recommendations

ACH580-01-	Input current A	UL			
		Maximum current	Voltage rating	Bussmann type ¹	UL class
		A	V		
3-phase $U_N = 575$ V					
02A7-6	2.7	15	600	KTK-R-15 or JJS-15	Class CC or T
03A9-6	3.9	15	600	KTK-R-15 or JJS-15	Class CC or T
06A1-6	6.1	15	600	KTK-R-15 or JJS-15	Class CC or T
09A0-6	9	15	600	KTK-R-15 or JJS-15	Class CC or T
011A-6	11	15	600	KTK-R-15 or JJS-15	Class CC or T
017A-6	17	30	600	KTK-R-30 or JJS-30	Class CC or T
022A-6	22	40	600	JJS-40	Class T
027A-6	27	40	600	JJS-40	Class T
032A-6	32	40	600	JJS-40	Class T
041A-6	41	100	600	JJS-100	Class T
052A-6	52	100	600	JJS-100	Class T
062A-6	62	100	600	JJS-100	Class T
077A-6	77	100	600	JJS-100	Class T
099A-6	99	150	600	JJS-150	Class T
125A-6	125	200	600	JJS-200	Class T
144A-6	144	250	600	JJS-250	Class T
180A-6	180	300	600	JJS-300	Class T
242A-6	242	400	600	JJS-400	Class T
271A-6	271	400	600	JJS-400	Class T

1) ABB does not require Bussmann brand fuses. Fuses which meet the appropriate UL class type, current rating, and are rated at 600V, 200 kA may be used.

External control connection terminals, frames R1...R5

The layout of the external control connection terminals of the R1 frame is shown below. Layout of the external control connection terminals is identical in frames R1...R5 but the location of the control board with the terminals is different in frames R3...R5.

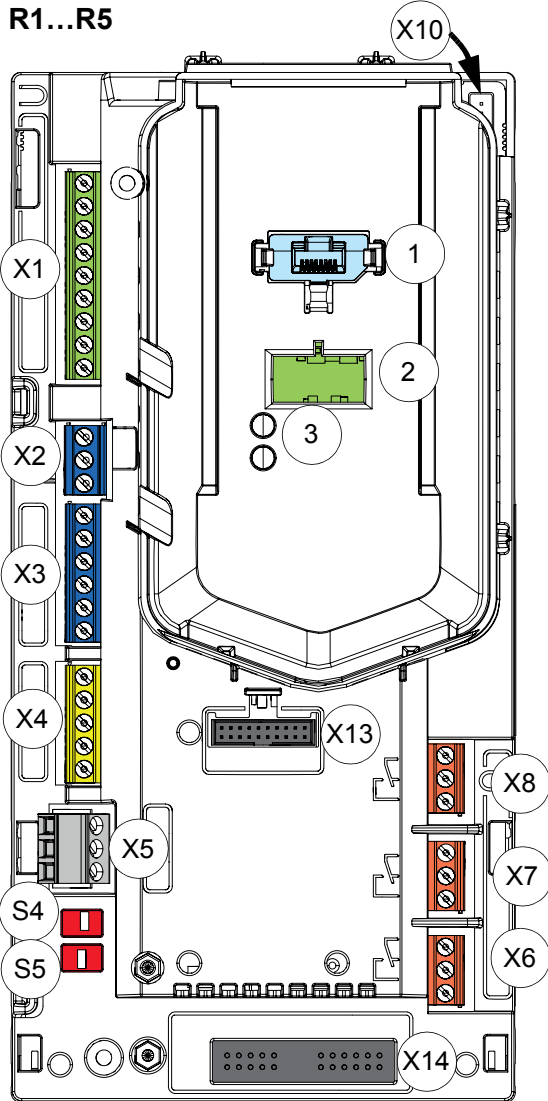

	Description
X1	Analog inputs and outputs
X2	Aux. voltage output
X3	Programmable digital inputs
X4	Safe torque off connection
X5	Embedded fieldbus
X6	Relay output 3
X7	Relay output 2
X8	Relay output 1
X10	Auxiliary fan connection (IP55)
X13	Option slot 1 (fieldbus adapter modules)
X14	Option slot 2 (I/O extension modules)
S4, S5	Termination switch (S4), bias resistor switch (S5), see section Switches on page 41
1	Panel port (control panel connection)
2	Cold configuration connection. This connector is used with the CCA-01 configuration adapter.
3	Power OK and Fault LEDs

External control connection terminals, frames R6...R9

The layout of the external control connection terminals of frames R6...R9 is shown below.

R6...R9

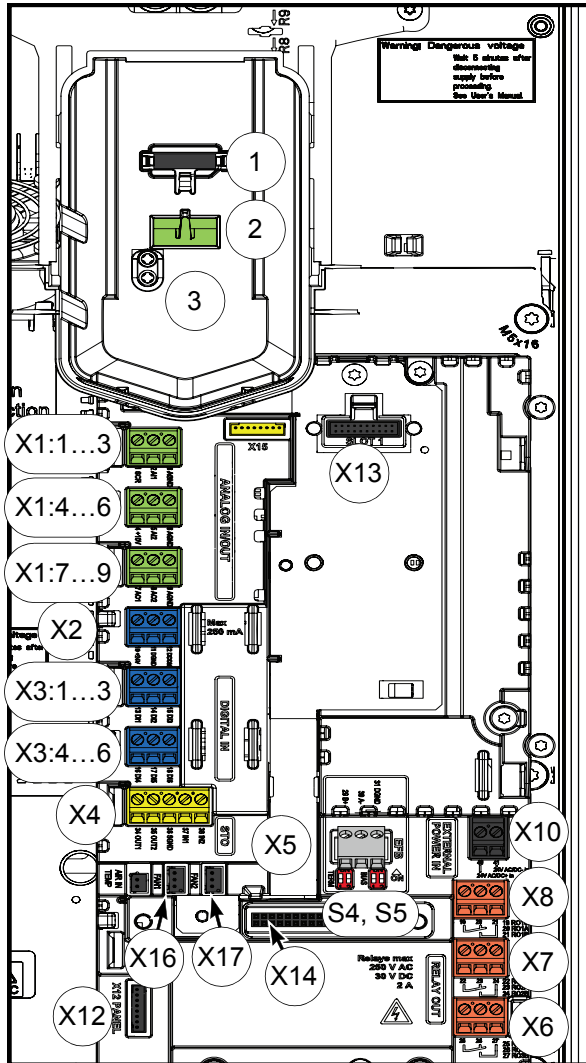

	Description
X1	Analog inputs and outputs
X2	Aux. voltage output
X3	Digital inputs
X4	Safe torque off connection
X5	Connection to embedded EIA-485 fieldbus adapter module
X6	Relay output 3
X7	Relay output 2
X8	Relay output 1
X10	External +24 V AC/DC input connection
X12	Panel connection
X13	Option slot 1 (fieldbus adapter modules)
X14	Option slot 2 (I/O extension modules)
X16	Auxiliary fan 1 connection
X17	Auxiliary fan 2 connection
S4, S5	Termination switch (S4), bias resistor switch (S5), see section Switches on page 41
1	Panel port (control panel connection)
2	Cold configuration connection. This connector is used with the CCA-01 configuration adapter.
3	Power OK and Fault LEDs



WARNING! If installing modules, the +24 V AC cable to the control board ground when the control board is powered using an external 24 V AC supply.

Wiring R1...R2

Note: These are instructions for conduit wiring. For cable wiring, see the [ACH580 Hardware manual](#), publication number [3AXD50000044839](#).

Note: In US deliveries, options are already installed at the factory. If installing on site, option slot 1 modules (fieldbus adapter) may be installed by mounting the module on the control board and tightening the mounting screw, which is also the grounding screw. Option slot 2 modules (I/O extension) should not be installed until after the power cables. Refer to Warning and step 8 below.



WARNING! If installing modules, obey the instructions in [Safety instructions](#) on page 2. If you ignore them, injury or death, or damage to the equipment can occur.

Option slot 2 in frames R1...R5 is at U_{DC} potential. You must disconnect power supplies before installing or removing an I/O extension module.

-
1. Install thin-wall conduit clamps for IP21/UL (NEMA) Type 1 or liquid-tight conduit connectors for IP55/UL (NEMA) Type 12 (not supplied). Type 12 has a Pressfit gasket.
 2. Connect conduit runs for input power, motor and control cables to the conduit box. Ensure grommets (pointing down) are inserted into all unused holes.
 3. Route the input power and motor wiring through separate conduits.
 4. Strip wires.
 5. Connect the motor and ground wires to the drive terminal. Tighten the screws to torques shown in the Power wiring torque table.
 6. Connect the input power and ground wires to the drive terminal. Tighten the screws to torques shown in the Power wiring torque table.
 7. *If brake resistor is used* — Connect the resistor and ground wires. Tighten the screws to torques shown in the Power wiring torque table.
 8. Install option slot 2 modules (I/O extension), if necessary, at this point.
 - A *Frame R1 only:* Install the option mounting.
 - B Put the module carefully into its position on the control board and tighten the mounting screw.
 - C Tighten the grounding screw, which is necessary for proper operation and for fulfilling EMC requirements.

Note: Frame R1 — The module in option slot 2 covers the power terminals. Do not install a module in option slot 2 before you have installed the power cables.

-
9. Route the control cables through the conduit (not the same conduit as either input power or motor wiring).
 10. Strip the control cable sheathing and twist the copper screen into a pig-tail.
 11. Refer to pages [39](#), [40](#) and [41](#). Connect the ground screen pig-tail for digital and analog I/O cables. (Ground only at drive end.)

12. Connect the ground screen pig-tail for Embedded fieldbus, EFB (EIA-485) cables at X5. (Ground only at drive end.)
13. Strip and connect the individual control wires to the drive terminals. Tighten the screws to 0.4 lb-ft (0.5...0.6 N•m).



WARNING! To avoid danger or damage to the drive on IT systems and corner grounded TN systems, see section [Checking the compatibility with IT \(ungrounded\) and corner-grounded TN systems \(North America\)](#) on page 17.

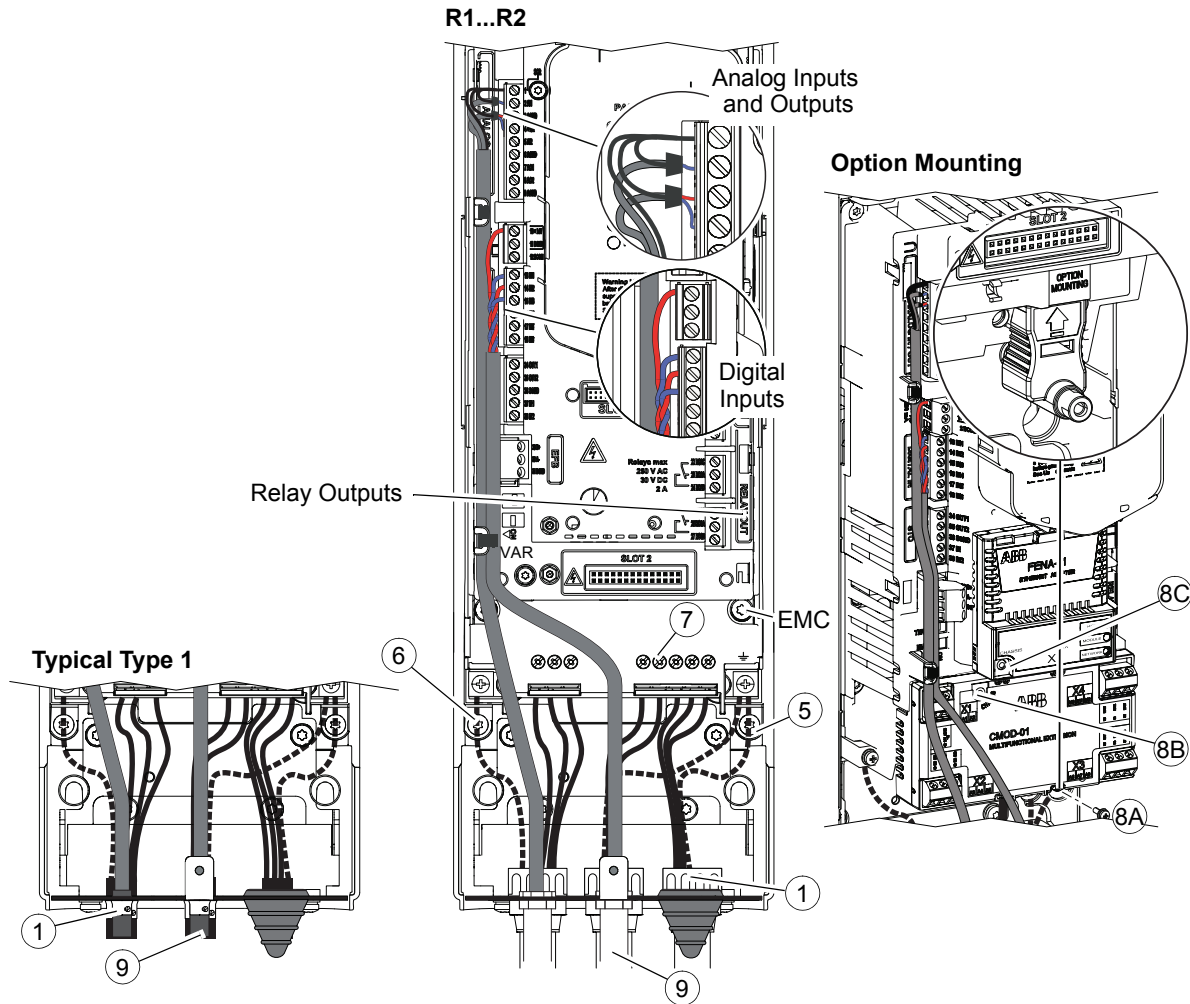

Power wiring torque table

Frame size	R1		R2	
	lb-ft	N•m	lb-ft	N•m
T1/U, T2/V, T3/W	0.7	1.0	1.1	1.5
L1, L2, L3	0.7	1.0	1.1	1.5
R+, R-	0.7	1.0	1.1	1.5
PE Ground	1.1	1.5	1.1	1.5

Wiring R3

Note: These are instructions for conduit wiring. For cable wiring, see the [ACH580 Hardware manual](#), publication number [3AXD50000044839](#).

Note: In US deliveries, options are already installed at the factory. If installing on site, option slot 1 modules (fieldbus adapter) may be installed by mounting the module on the control board and tightening the mounting screw, which is also the grounding screw. Option slot 2 modules (I/O extension) may be installed by mounting the module on the control board and tightening both the mounting screw and the grounding screw. Refer to Warning.



WARNING! If installing modules, obey the instructions in [Safety instructions](#) on page 2. If you ignore them, injury or death, or damage to the equipment can occur.

Option slot 2 in frames R1...R5 is at U_{DC} potential. You must disconnect power supplies before installing or removing an I/O extension module.

1. Install thin-wall conduit clamps for IP21/UL (NEMA) Type 1 or liquid-tight conduit connectors for IP55/UL (NEMA) Type 12 (not supplied). Type 12 has a Pressfit gasket.
2. Connect conduit runs for input power, motor and control cables to the conduit box. Ensure grommets (pointing down) are inserted into all unused holes.
3. Route the input power and motor wiring through separate conduits.
4. Strip wires.
5. Connect the motor and ground wires to the drive terminal. Tighten the screws to torques shown in the Power wiring torque table.
6. Connect the input power and ground wires to the drive terminal. Tighten the screws to torques shown in the Power wiring torque table.
7. *If brake resistor is used* — Connect the resistor and ground wires. Tighten the screws to torques shown in the Power wiring torque table.
8. Route the control cables through the conduit (not the same conduit as either input power or motor wiring).
9. Strip the control cable sheathing and twist the copper screen into a pig-tail.
10. Refer to pages [39](#), [40](#) and [41](#). Connect the ground screen pig-tail for digital and analog I/O cables. (Ground only at drive end.)
11. Connect the ground screen pig-tail for Embedded fieldbus, EFB (EIA-485) cables at X5. (Ground only at drive end.)
12. Strip and connect the individual control wires to the drive terminals. Tighten the screws to 0.4 lb-ft (0.5...0.6 N•m).



WARNING! To avoid danger or damage to the drive on IT systems and corner grounded TN systems, see section [Checking the compatibility with IT \(ungrounded\) and corner-grounded TN systems \(North America\)](#) on page 17.

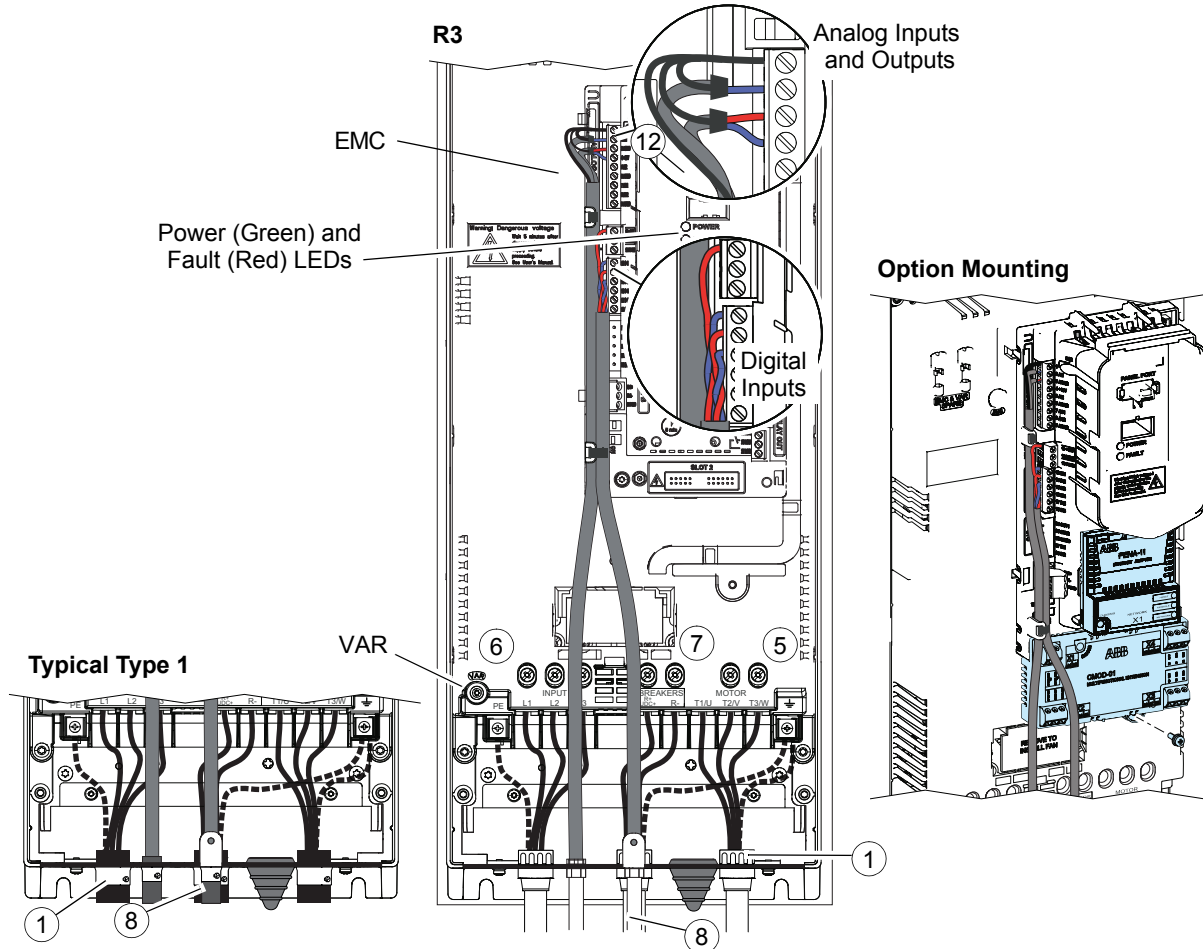

Power wiring torque table

Frame size	R3	
	lb-ft	N•m
T1/U, T2/V, T3/W	2.6	3.5
L1, L2, L3	2.6	3.5
R+, R-	2.6	3.5
PE Ground	1.1	1.5

Wiring R4

Note: These are instructions for conduit wiring. For cable wiring, see the [ACH580 Hardware manual](#), publication number [3AXD50000044839](#).

Note: In US deliveries, options are already installed at the factory. If installing on site, option slot 1 modules (fieldbus adapter) may be installed by mounting the module on the control board and tightening the mounting screw, which is also the grounding screw. Option slot 2 modules (I/O extension) may be installed by mounting the module on the control board and tightening both the mounting screw and the grounding screw. Refer to Warning.



WARNING! If installing modules, obey the instructions in [Safety instructions](#) on page 2. If you ignore them, injury or death, or damage to the equipment can occur.

Option slot 2 in frames R1...R5 is at U_{DC} potential. You must disconnect power supplies before installing or removing an I/O extension module.

1. Install thin-wall conduit clamps for IP21/UL (NEMA) Type 1 or liquid-tight conduit connectors for IP55/UL (NEMA) Type 12 (not supplied). Type 12 has a Pressfit gasket.
2. Connect conduit runs for input power, motor and control cables to the conduit box. Ensure grommets (pointed down) are inserted into all unused holes.
3. Route the input power and motor wiring through separate conduits.
4. Strip wires.
5. Connect the motor and ground wires to the drive terminal. Tighten the screws to torques shown in the Power wiring torque table.
6. Connect the input power and ground wires to the drive terminal. Tighten the screws to torques shown in the Power wiring torque table.
7. Route the control cables through the conduit (not the same conduit as either input power or motor wiring).
8. Strip the control cable sheathing and twist the copper screen into a pig-tail.
9. Refer to pages [39](#), [40](#) and [41](#). Connect the ground screen pig-tail for digital and analog I/O cables. (Ground only at drive end.)
10. Connect the ground screen pig-tail for Embedded fieldbus, EFB (EIA-485) cables at X5. (Ground only at drive end.)
11. Strip and connect the individual control wires to the drive terminals. Tighten the screws to 0.4 lb-ft (0.5...0.6 N•m).



WARNING! To avoid danger or damage to the drive on IT systems and corner grounded TN systems, see section [Checking the compatibility with IT \(ungrounded\) and corner-grounded TN systems \(North America\)](#) on page 17.

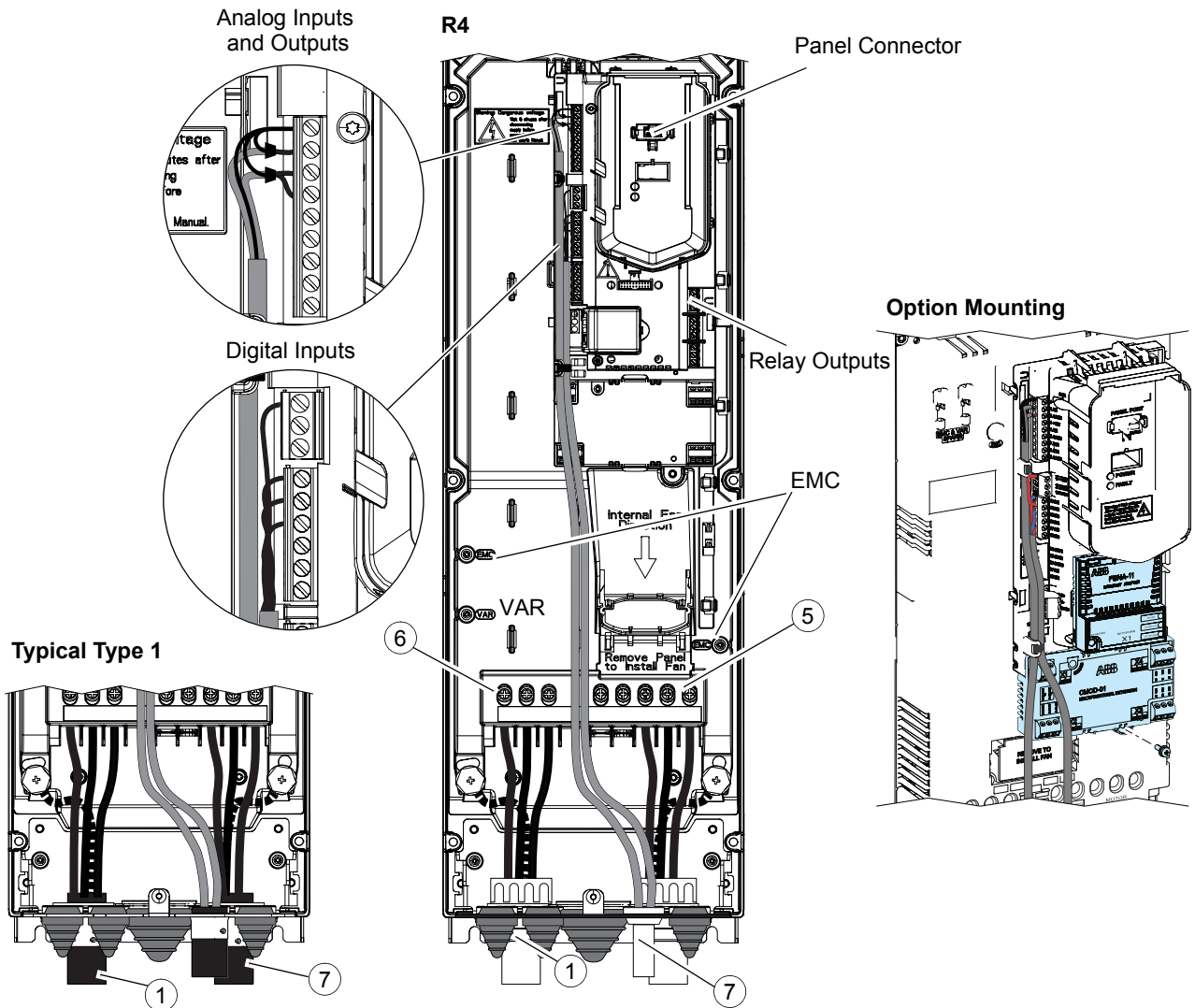

Note: UDC+ and UDC- terminals are used for external brake chopper units.

Power wiring torque table

Frame size	R4	
	lb-ft	N•m
T1/U, T2/V, T3/W	3.0	4.0
L1, L2, L3	3.0	4.0
UDC+ and UDC-	3.0	4.0
PE Ground	2.1	2.9

Wiring R5

Note: These are instructions for conduit wiring. For cable wiring, see the [ACH580 Hardware manual](#), publication number [3AXD50000044839](#).

Note: In US deliveries, options are already installed at the factory. If installing on site, option slot 1 modules (fieldbus adapter) may be installed by mounting the module on the control board and tightening the mounting screw, which is also the grounding screw. Option slot 2 modules (I/O extension) may be installed by mounting the module on the control board and tightening both the mounting screw and the grounding screw. Refer to Warning.



WARNING! If installing modules, obey the instructions in [Safety instructions](#) on page 2. If you ignore them, injury or death, or damage to the equipment can occur.

Option slot 2 in frames R1...R5 is at U_{DC} potential. You must disconnect power supplies before installing or removing an I/O extension module.

1. Install thin-wall conduit clamps for IP21/UL (NEMA) Type 1 or liquid-tight conduit connectors for IP55/UL (NEMA) Type 12 (not supplied). Type 12 has a Pressfit gasket.
2. Connect conduit runs for input power, motor and control cables to the conduit box. Ensure grommets (pointing down) are inserted into all unused holes.
3. Route the input power and motor wiring through separate conduits.
4. Strip wires.
5. Connect the motor and ground wires to the drive terminal. Tighten the screws to torques shown in the Power wiring torque table.
6. Connect the input power and ground wires to the drive terminal. Tighten the screws to torques shown in the Power wiring torque table.
7. Reinstall the shroud on the power terminals by putting the tabs at the top of the shroud in their counterparts on the drive frame and then pressing the shroud in place.
8. Route the control cables through the conduit (not the same conduit as either input power or motor wiring).
9. Strip the control cable sheathing and twist the copper screen into a pig-tail.
10. Refer to pages [39](#), [40](#) and [41](#). Connect the ground screen pig-tail for digital and analog I/O cables. (Ground only at drive end.)
11. Connect the ground screen pig-tail for Embedded fieldbus, EFB (EIA-485) cables at X5. (Ground only at drive end.)

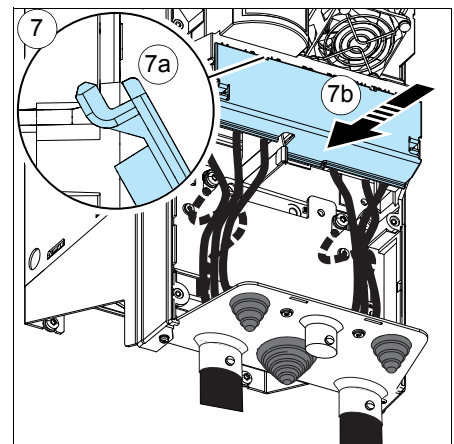

12. Strip and connect the individual control wires to the drive terminals. Tighten the screws to 0.4 lb-ft (0.5...0.6 N•m).



WARNING! To avoid danger or damage to the drive on IT systems and corner grounded TN systems, see section [Checking the compatibility with IT \(ungrounded\) and corner-grounded TN systems \(North America\)](#) on page 17.

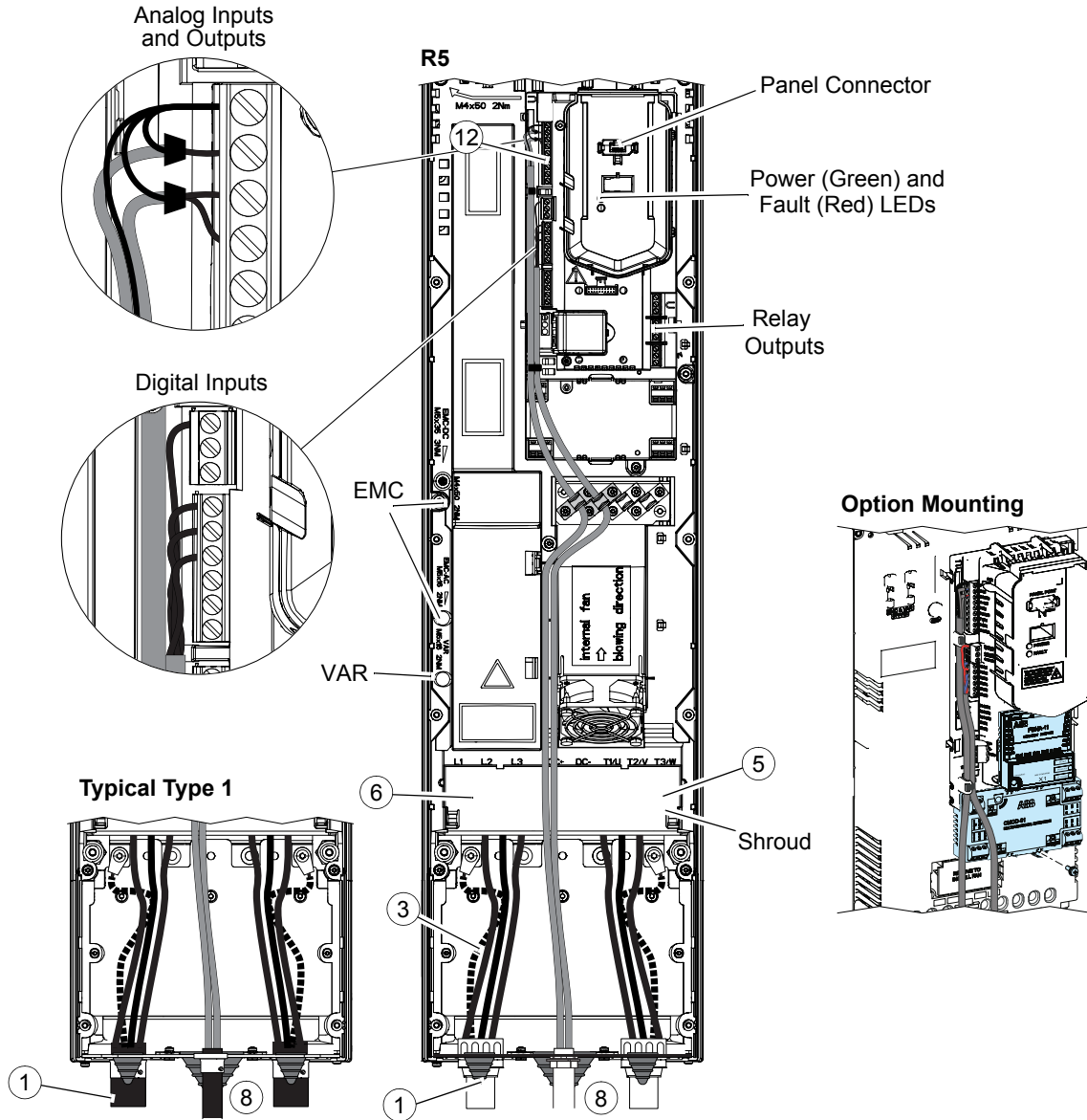

Note: UDC+ and UDC- terminals are used for external brake chopper units.

Power wiring torque table

Frame size	R5	
	lb-ft	N•m
T1/U, T2/V, T3/W	4.1	5.6

Frame size	R5	
	lb-ft	N•m
L1, L2, L3	4.1	5.6
UDC+ and UDC-	4.1	5.6
PE Ground	1.6	2.2

Wiring R6...R9

Note: These are instructions for conduit wiring. For cable wiring, see the [ACH580 Hardware manual](#), publication number [3AXD50000044839](#).

Note: In US deliveries, options are already installed at the factory. If installing on site, see the appropriate option module manual for specific installation and wiring.

1. Install thin-wall conduit clamps for IP21/UL (NEMA) Type 1 or liquid-tight conduit connectors for IP55/UL (NEMA) Type 12 (not supplied). Type 12 has a Pressfit gasket.
 2. Connect conduit runs for input power, motor and control cables to the conduit box. Ensure grommets (pointing down) are inserted into all unused holes.
 3. Route the input power and motor wiring through separate conduits.
 4. Strip wires.
 5. Connect the motor and ground wires to the drive terminal. Tighten the screws to torques shown in the Power wiring torque table.
-

Note: *Frames R8...R9* — If you connect only one conductor to the connector, we recommend that you put it under the upper pressure plate.

6. Connect the input power and ground wires to the drive terminal. Tighten the screws to torques shown in the Power wiring torque table.
 7. *Frames R8...R9* — If parallel cables are used, install the parallel power cables.
 8. Reinstall the shroud on the power terminals and the conduit box side plates.
 9. Route the control cables through the conduit (not the same conduit as either input power or motor wiring).
 10. Strip the control cable sheathing and twist the copper screen into a pig-tail.
 11. Refer to pages [39](#), [40](#) and [41](#). Connect the ground screen pig-tail for digital and analog I/O cables. (Ground only at drive end.)
 12. Connect the ground screen pig-tail for Embedded fieldbus, EFB (EIA-485) cables at X5. (Ground only at drive end.)
 13. Strip and connect the individual control wires to the drive terminals. Tighten the screws to 0.4 lb-ft (0.5...0.6 N•m).
-



WARNING! To avoid danger or damage to the drive on IT systems and corner grounded TN systems, see section [Checking the compatibility with IT \(ungrounded\) and corner-grounded TN systems \(North America\)](#) on page 17.

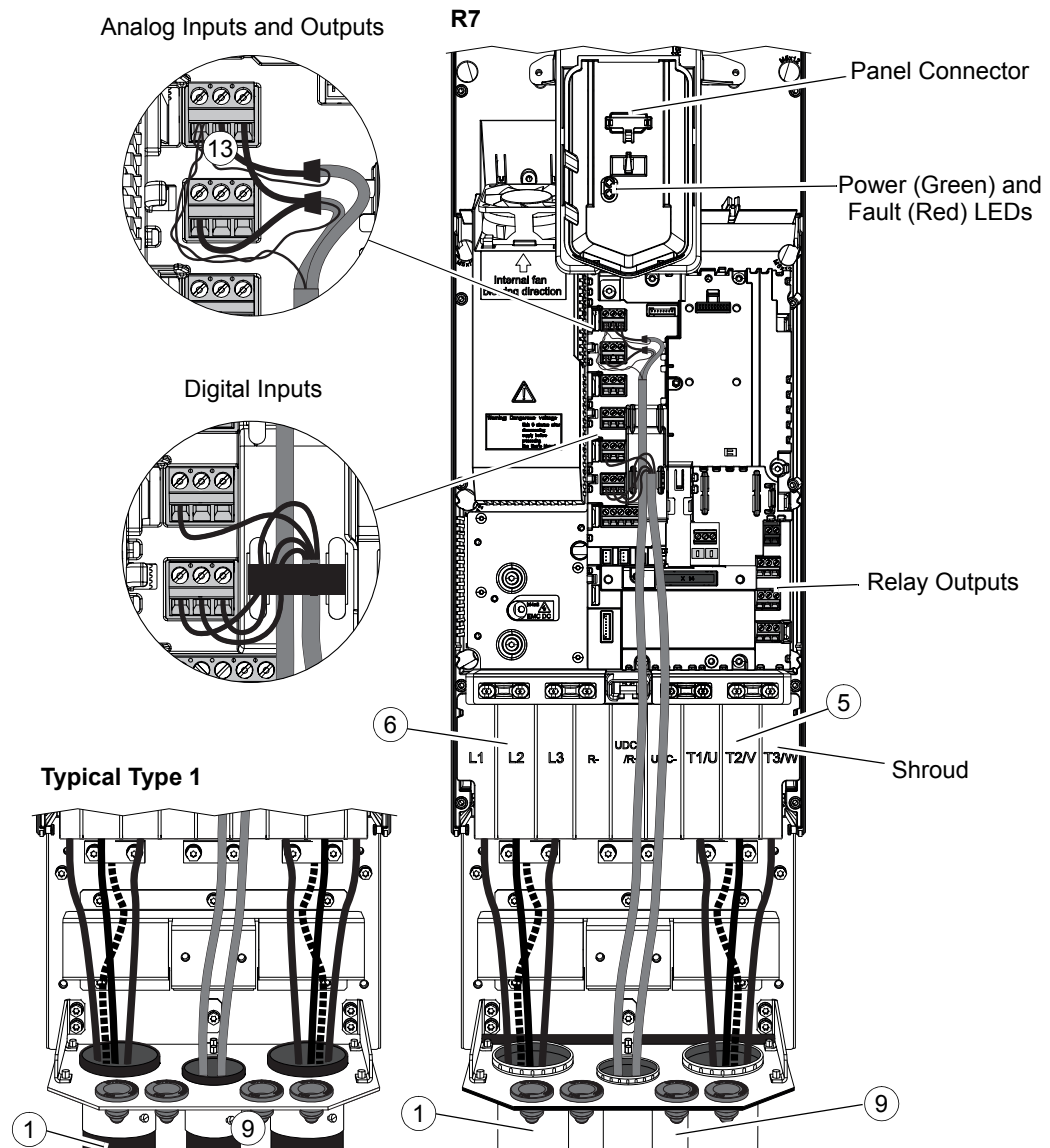

Note: UDC+ and UDC- terminals are used for external brake chopper units.

Power wiring torque table

Frame size	R6		R7		R8		R9	
	lb-ft	N•m	lb-ft	N•m	lb-ft	N•m	lb-ft	N•m
T1/U, T2/V, T3/W	22.1	30	29.5	40	29.6	40	51.6	70
L1, L2, L3	22.1	30	29.5	40	29.6	40	51.6	70
UDC+ and UDC-	22.1	30	29.5	30	29.5	40	51.6	70
PE Ground	7.2	9.8	7.2	9.8	7.2	9.8	7.2	9.8

Default control connections for the HVAC default

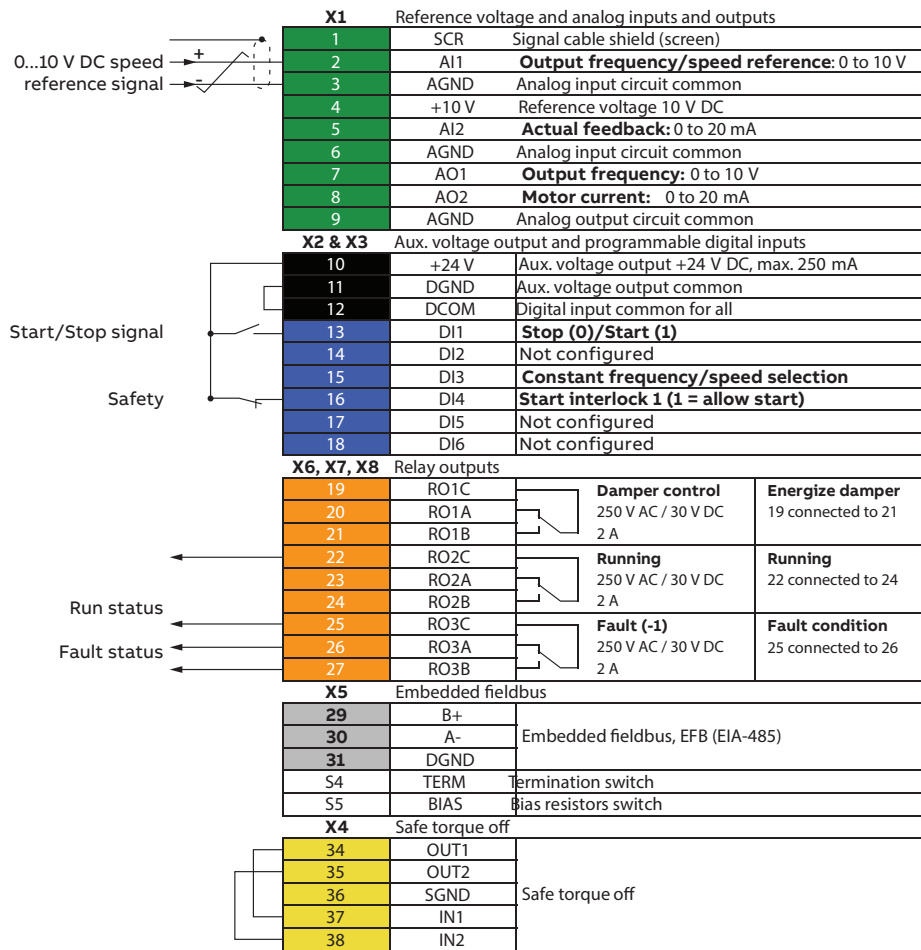

Notes:

- 1) Ground the outer shield of the cable 360 degrees under the grounding clamp on the grounding shelf for the control cables.
- 2) Connected with jumpers at the factory.
- 3) Only frames R6...R11 have terminals 40 and 41 for external 24 V AC/DC input.

Terminal sizes:

1. R1...R5: 24...14 AWG (0.2...2.5 mm²): Terminals +24V, DGND, DCOM, B+, A-, DGND, Ext. 24V
2. 26...16 AWG (0.14...1.5 mm²): Terminals DI, AI, AO, AGND, RO, STO
3. R6...R9: 26...14 AWG (0.14...2.5 mm²) (all terminals)
4. Tightening torques: 0.4 lb-ft (0.5...0.6 N•m)

HVAC default direct I/O control	
Input Signals	Output signals
• Analog frequency/speed reference (AI1)	• Analog output AO1: Output frequency
• Start/stop selection (DI1)	• Analog output AO2: Motor current
• Constant speed/frequency selection (DI3)	• Relay output 1: Damper control
• Start interlock 1 (DI4)	• Relay output 2: Running
	• Relay output 3: Fault (-1)

Default control connections for the PID control, single motor

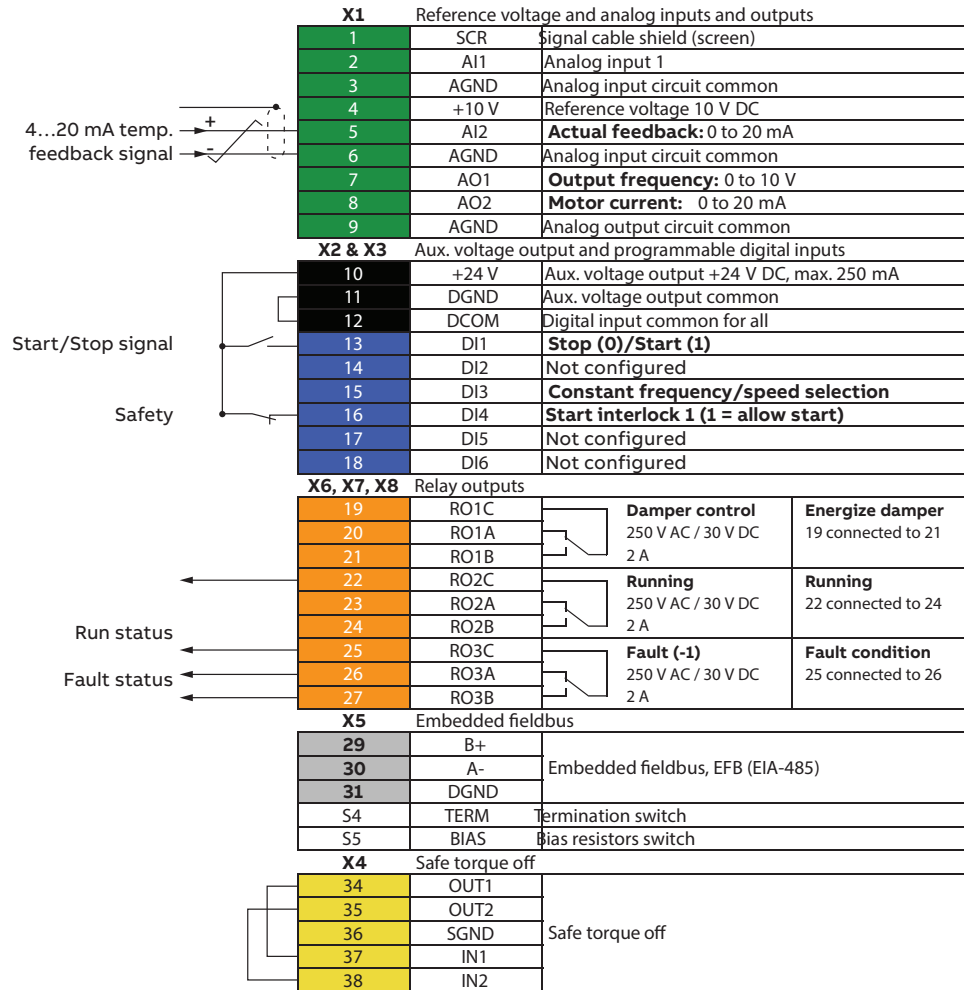

- 1) Connected with jumpers at the factory.
- 2) Only frames R6...R9 have terminals 40 and 41 for external 24 V AC/DC input.

Terminal sizes:

1. R1...R5: 24...14 AWG (0.2...2.5 mm²): Terminals +24V, DGND, DCOM, B+, A-, DGND, Ext. 24V
2. 26...16 AWG (0.14...1.5 mm²): Terminals DI, AI, AO, AGND, RO, STO
3. R6...R9: 26...14 AWG (0.14...2.5 mm²) (all terminals)
4. Tightening torques: 0.4 lb-ft (0.5...0.6 N•m)

PID control, single motor	
Input signals	Output signals
<ul style="list-style-type: none"> Setpoint selected from: control panel setpoint/constant setpoint /analog input (AI1) 	<ul style="list-style-type: none"> Analog output AO1: Output frequency
<ul style="list-style-type: none"> PID feedback (AI2) 	<ul style="list-style-type: none"> Analog output AO2: Motor current
<ul style="list-style-type: none"> Start/stop selection (DI1) 	<ul style="list-style-type: none"> Relay output 1: Damper control
<ul style="list-style-type: none"> Constant speed/frequency selection (DI3) 	<ul style="list-style-type: none"> Relay output 2: Running
<ul style="list-style-type: none"> Start interlock 1 (DI4) 	<ul style="list-style-type: none"> Relay output 3: Fault (-1)

You can wire the digital input terminals for internal or external power supply in either a PNP or NPN configuration.

Internal +24 V power supply

PNP connection (source)

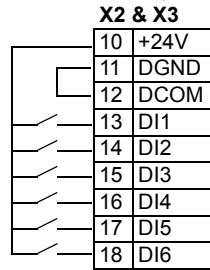

External +24 V power supply

PNP connection (source)

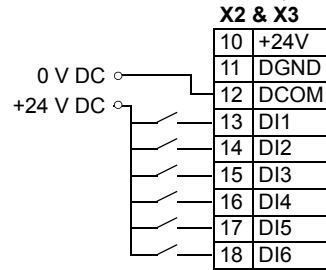

Internal +24 V power supply

NPN connection (sink)

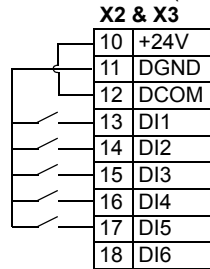

External +24 V power supply

NPN connection (sink)

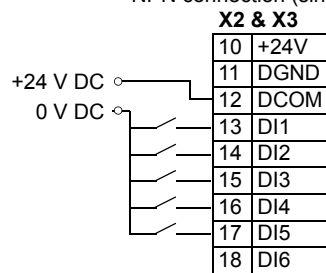

Note: DI6 is not supported in the NPN configuration.



WARNING! Do not connect the +24 V AC cable to the control board ground when the control board is powered using an external 24 V AC supply.

Communications

Terminals 29...31 provide Embedded fieldbus, EFB (EIA-485) connections used to control or monitor the drive from a fieldbus controller.

Switches

Switch	Description	Position	
S4 (TERM)	EFB link termination. Must be set to the terminated (ON) position when the drive is the first or last unit on the link.		Bus not terminated (default)
			Bus terminated
S5 (BIAS)	Switches on the biasing voltages to the bus. One (and only one) device, preferably at the end of the bus must have the bias on.		Bias off (default)
			Bias on

5. Check installation

Before applying power, perform the following checks.

<input checked="" type="checkbox"/>	Check that ...
<input type="checkbox"/>	The ambient operating conditions meet the specification.
<input type="checkbox"/>	If the drive will be connected to a corner-grounded TN system: The internal EMC filter is disconnected. (No metal screws.)
<input type="checkbox"/>	If the drive will be connected to an IT (ungrounded) system: The internal EMC filter and the ground-to-phase varistor is disconnected. (No metal screws.)
<input type="checkbox"/>	If the drive has not been powered (either in storage or unused) over one year: The electrolytic DC capacitors in the DC link of the drive have been reformed.
<input type="checkbox"/>	There is an adequately sized protective earth (ground) conductor between the drive and the switchboard.
<input type="checkbox"/>	There is an adequately sized protective earth (ground) conductor between the motor and the drive.
<input type="checkbox"/>	All protective earth (ground) conductors have been connected to the appropriate terminals and the terminals have been tightened.
<input type="checkbox"/>	The supply voltage matches the nominal input voltage of the drive. Check the type designation label.
<input type="checkbox"/>	The input power cable has been connected to appropriate terminals, and the terminals have been properly tightened.
<input type="checkbox"/>	Appropriate supply fuses and disconnectors have been installed.
<input type="checkbox"/>	The motor cable has been connected to appropriate terminals and the terminals have been tightened.
<input type="checkbox"/>	The brake resistor cable (if present) has been connected to appropriate terminals, and the terminals have been tightened.
<input type="checkbox"/>	The motor cable (and brake resistor cable, if present) have been properly wired through conduits.
<input type="checkbox"/>	The control cables (if any) have been connected to the control board.
<input type="checkbox"/>	There are no tools, foreign objects or dust from drilling inside the drive.
<input type="checkbox"/>	Drive and motor connection box covers are in place.
<input type="checkbox"/>	The motor and the driven equipment are ready for start-up.

6. Re-install cover(s)

Frames R1...R4

1. Reinstall the cover: Put the tabs on the cover top in their counterparts on the housing (1a) and then press the cover (1b)
2. Tighten the retaining screw at the bottom with a screwdriver.

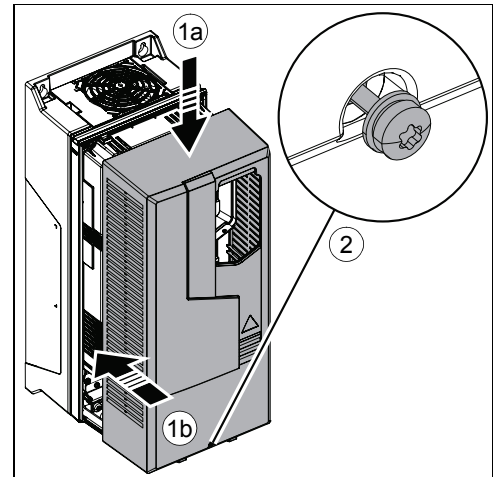

Frame R5 cover installations

1. Slide the conduit box upwards (1a) and tighten the retaining screws (1b).
2. Install the cover, press it at the bottom (2a) and tighten the retaining screws (2b).

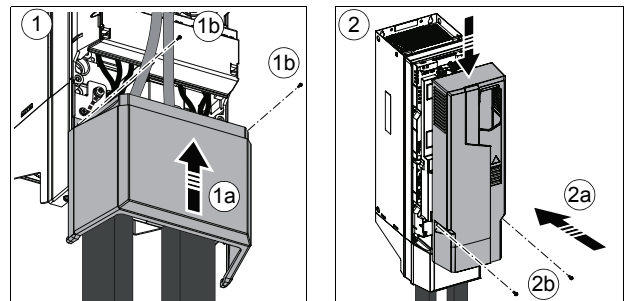

7. Install hood, if applicable

IP 55/UL (NEMA) Type 12, Frame R1...R9

Install the hood by following the instructions provided with the hood kit.

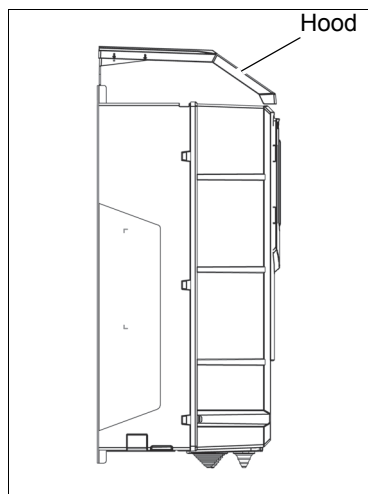

8. Before Start-up

Prepare for start-up by reviewing the following information. The First start assistant walks you through the initial start-up procedure.

Motor data

The motor data on the ratings plate may differ from the defaults in the ACH580. The drive provides more precise control and better thermal protection if you enter the rating plate data.

Before start-up, gather the following from the motor ratings plate:

- Nominal motor current
- Nominal speed
- Voltage
- Nominal frequency
- Nominal power

Default configurations

After initial start-up, you will need to complete the commissioning. This will determine how the drive is controlled, let you make use of default configurations, and allow you to change specific parameters. See [2. Complete commissioning on page 50](#).

The ACH580 can be controlled by two default configurations.

HVAC default direct I/O control – Used for typical I/O controlled BMS applications.

- In the Auto mode, this configuration uses a direct speed reference connected to analog input 1 (AI1).
- In the Hand/Off mode, the speed reference and start command are given through the control panel (operator keypad).
- See the [Default control connections for the HVAC default on page 39](#).

PID control, single motor – Offers quick setup of PID control for keeping flow or pressure constant, requiring feedback from the process given by a feedback signal connected to analog input 2 (AI2).

- You can set a constant setpoint, or, in the Auto mode, you can specify the setpoint to come from analog input 1 (AI1) or from the control panel.
- In the Hand/Off mode, the speed reference and start command come from the control panel.
- In the Hand mode, the speed reference is the direct speed reference and a PID setpoint value.
- See the [Default control connections for the PID control, single motor on page 40](#).

Operation

The ACH580 HVAC control panel features:

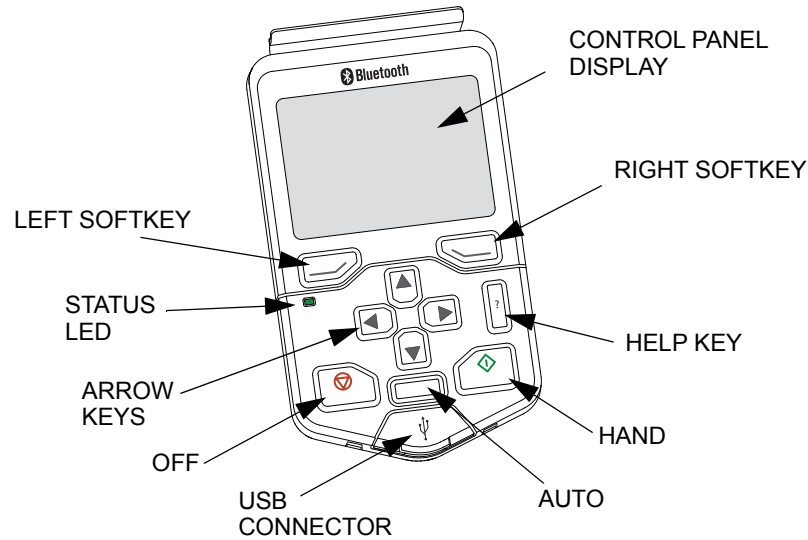

Control panel features

Left softkey

The left softkey (☐) is usually used for exiting and canceling. Its function in a given situation is shown by the softkey selection in the bottom left corner of the display.

Holding ☐ down exits each view in turn until you are back in the Home view. This function does not work in special screens.

Right softkey

The right softkey (☐) is usually used for selecting, accepting and confirming. The function of the right softkey in a given situation is shown by the softkey selection in the bottom right corner of the display.

The arrow keys

The up and down arrow keys (▲ and ▼) are used to highlight selections in menus and selection lists, to scroll up and down on text pages, and to adjust values when, for example, setting the time, entering a passcode or changing a parameter value.

The left and right arrow keys (◀ and ▶) are used to move the cursor left and right in parameter editing and to move forward and backward in assistants. In menus, ◀ and ▶ function the same way as ☐ and ☐, respectively.

Help

The help key (?) opens a help page. The help page is context-sensitive, in other words, the content of the page is relevant to the menu or view in question.

Hand, Off and Auto

The ACH580 can be in local or external control. The local control has two modes: Hand and Off.

Hand key ():

- In local control / Off mode: Starts the drive. The drive will switch to the Hand mode.
- In external control: Switches the drive to local control / Hand mode, keeping it running.

Off key ():

- Stops the drive and switches to the Off mode.

Auto key ():

- In local control: The drive will switch to external control.

Control panel display

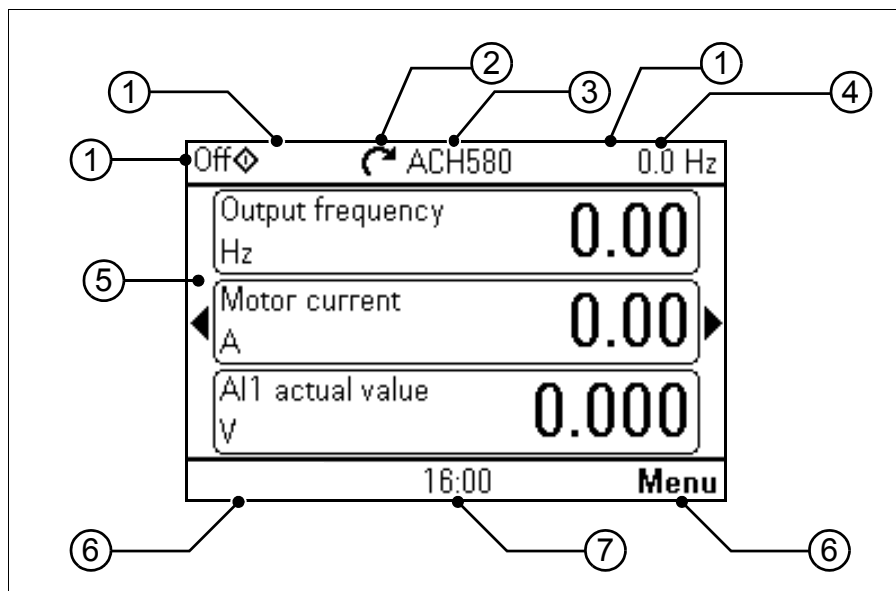

1. Control location and related icons
2. Status icon
3. Drive name
4. Reference value
5. Content area
6. Softkey selections
7. Clock

Note: Complete programming information is available in the *ACH580 HVAC control program firmware manual*, publication number 3AXD50000027537.

For initial start-up, follow steps 1 through 4 below.



WARNING! Do not start up the drive unless you are a qualified electrical professional.

Read and obey the instructions in chapter Safety instructions at the beginning of the manual. Ignoring the instructions can cause physical injury or death, or damage to the equipment.



WARNING! Verify there is no active start command on drive terminal DI1 on power up, as this is default run command.

Check that the starting of the motor does not cause any danger.











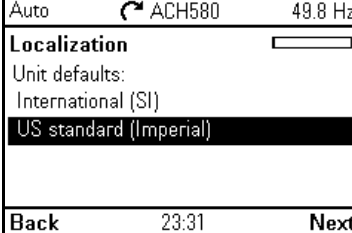

De-couple the driven machine if

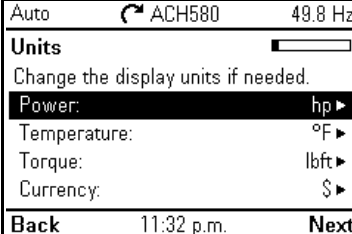
- there is a risk of damage in case of an incorrect direction of rotation, or
- a **Normal** ID run is required during the drive start-up, when the load torque is higher than 20% or the machinery is not able to withstand the nominal torque transient during the ID run.

Note: For additional E-Clipse bypass primary settings information please go to page [111](#).

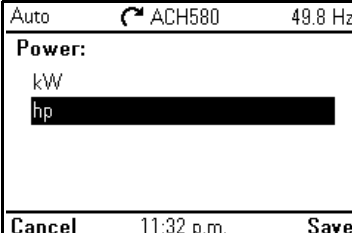
1. Make *First start assistant*-guided settings: Language, motor nominal values, and date and time

1	Have the motor name plate data at hand. Power up the drive.	
2	The First start assistant guides you through the first start-up. The assistant begins automatically. Wait until the control panel enters the view shown on the right. English is pre-loaded. To change the control panel, select the language you want to use by highlighting it and pressing (OK). Note: After you have selected the language, it takes a few minutes to download the language file to the control panel.	
3	Select Commission the ACH580 and press (Next).	

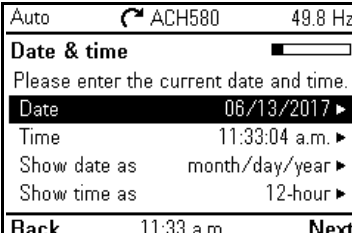
<p>4</p>	<p>Select the localization you want to use and press  (Next).</p>	
<p>5</p>	<p>Change the units shown on the panel if needed. Go to the edit view of a selected row by pressing . Scroll the view with  and . Go to the next view by pressing  (Next).</p>	
<p>6</p>	<p>To select a value in an edit view: Use  and  to select the value. Press  (Save) to accept the new setting, or press  (Cancel) to go back to the previous view without making changes.</p>	
<p>7</p>	<p>Set the date and time as well as date and time display formats. Go to the edit view of a selected row by pressing . Scroll the view with  and . Go to the next view by pressing  (Next).</p>	

Note: Enter the following values exactly as shown on the motor nameplate.

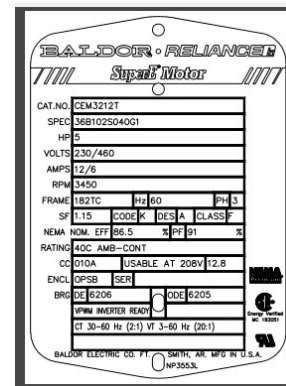

Example of a nameplate of an induction (asynchronous) motor.

<p>8</p>	<p>Check that the motor data is correct. Values are predefined on the basis of the drive size but you should verify that they correspond to the motor.</p> <p>Start with the motor type.</p> <p>Go to the edit view of a selected row by pressing .</p> <p>Scroll the view with and .</p> <p>Motor nominal cos Φ and nominal torque are optional.</p> <p>Press (Next) to continue.</p>	
<p>9</p>	<p>To change a value in an edit view:</p> <p>Use and to move the cursor left and right.</p> <p>Use and to change the value.</p> <p>Press (Save) to accept the new setting, or press (Cancel) to go back to the previous view without making changes.</p>	
<p>10</p>	<p>This step is optional, and requires rotating the motor. Do not do this if it could cause any risk, or if the mechanical setup does not allow it.</p> <p>To do the direction test, select Spin the motor and press (Next).</p>	
<p>11</p>	<p>Press the Hand key on the panel to start the drive.</p>	
<p>12</p>	<p>Check the direction of the motor.</p> <p>If it is forward, select Yes, motor is spinning forward and press (Next) to continue.</p> <p>If the direction is not forward, select No, fix direction and press (Next) to continue.</p>	
<p>13</p>	<p>The first start is now complete and the drive is ready for use.</p> <p>Press (Done) to enter the Home view.</p>	

2. Complete commissioning

Default configurations — HVAC and PID Control

For more information on Default configurations, see pages 39, 40 and 44.

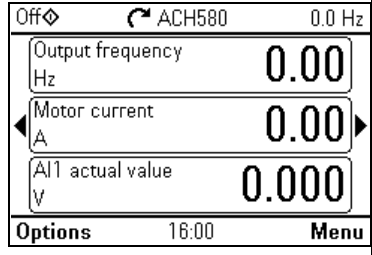
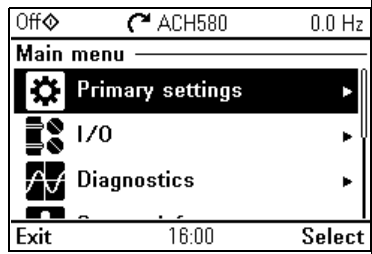
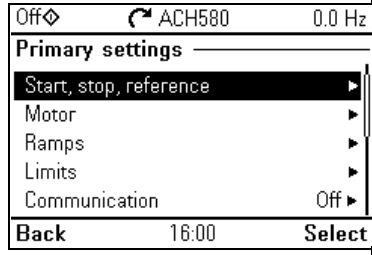
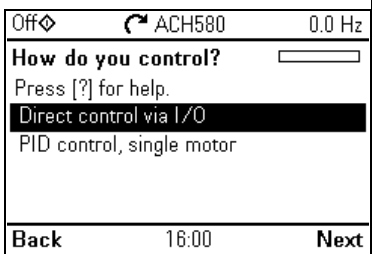
<p>1</p>	<p>Press the Hand key to start the motor. The Home view is shown on the panel. Select Menu (press on the soft key under "Menu").</p>	
<p>2</p>	<p>From the Main menu, select Primary settings.</p>	
<p>3</p>	<p>Select Start, stop, reference and How do you control?</p>	
<p>4</p>	<p>The default configurations are shown on the panel. For HVAC, press Direct control via I/O. For PID Control, press PID control, single motor.</p>	



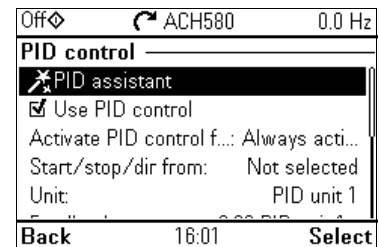



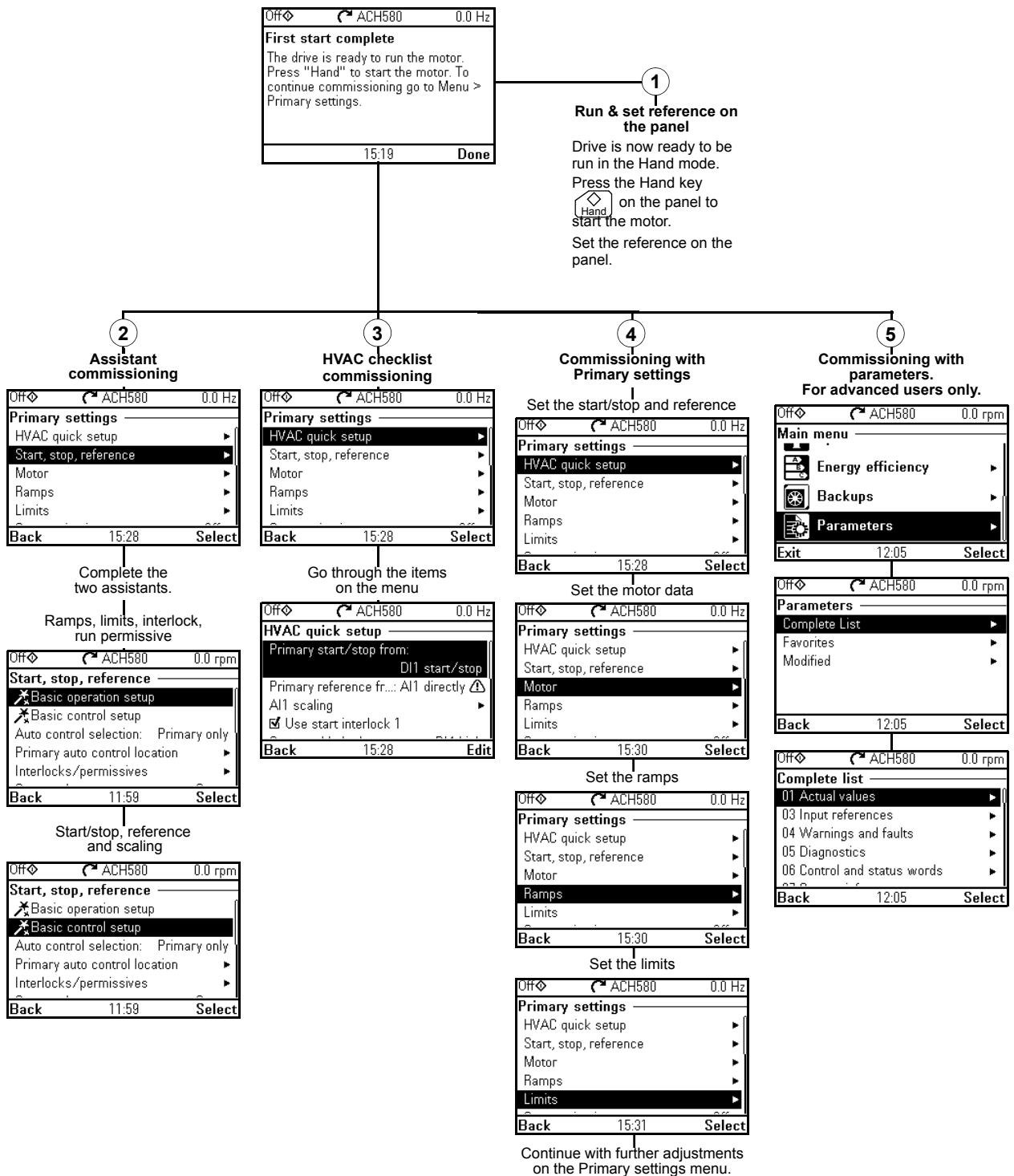



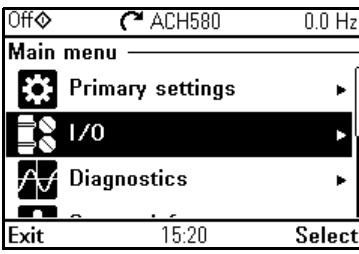

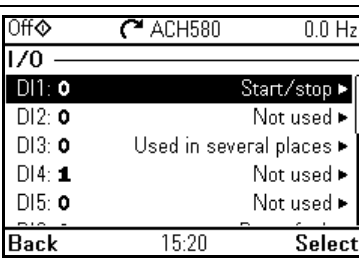
Note: You can adjust Process PI(D) in the PID control submenu of the Primary Settings menu after you have commissioned the drive to use PID control.

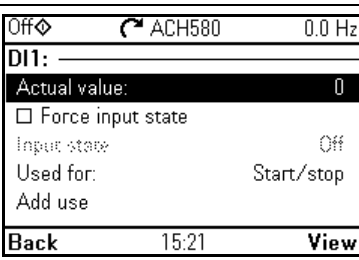





Other ways to complete commissioning



3. Make additional settings in the Primary settings menu – I/O menu

<p>1</p>	<p>After the additional adjustments, make sure that the actual I/O wiring matches the I/O use in the control program. In the Main menu, select a I/O and press  (Select) to enter the I/O menu.</p>	
<p>2</p>	<p>Select the connection you want to check and press  (Select) (or ).</p>	
<p>3</p>	<p>To view the details of a parameter that cannot be adjusted via the I/O menu, press  (View).</p>	
<p>4</p>	<p>To adjust the value of a parameter, press  (Edit), adjust the value using , ,  and  keys and press  (Save). Note that the actual wiring must match the new value. Go back to the Main menu by pressing  (Back) repeatedly.</p>	

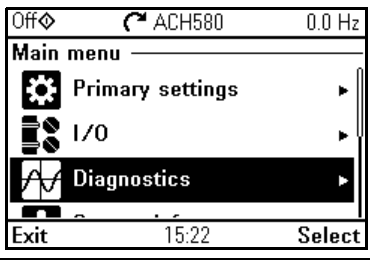
4. Check setup with the Diagnostics menu

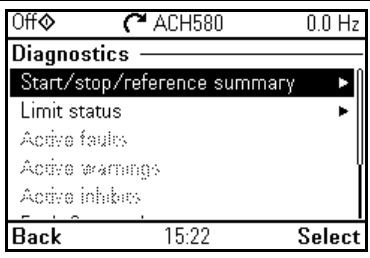
<p>1</p>	<p>After making the additional adjustments and checking the I/O connections, use the Diagnostics menu to make sure that the setup is functioning correctly.</p> <p>In the Main menu, select Diagnostics and press  (Select) (or ).</p>	 <p>The screenshot shows the 'Main menu' with three options: 'Primary settings', 'I/O', and 'Diagnostics'. The 'Diagnostics' option is highlighted with a black bar. At the bottom, there are three buttons: 'Exit', '15:22', and 'Select'.</p>
<p>2</p>	<p>Select the diagnostics item you want to view and press  (Select).</p> <p>Return to the Diagnostics menu by pressing  (Back).</p>	 <p>The screenshot shows the 'Diagnostics' menu with four options: 'Start/stop/reference summary', 'Limit status', 'Active faults', and 'Active warnings'. The 'Start/stop/reference summary' option is highlighted with a black bar. At the bottom, there are three buttons: 'Back', '15:22', and 'Select'.</p>

How to control the drive through the I/O interface

Instructions below are for operating the drive through the digital and analog inputs when:

- the motor start-up is performed, and
- the default parameter settings of the HVAC default configurations are in use.

Preliminary settings

If you need to change the direction of rotation, check that limits allow reverse direction. Check parameter group *30 Limits* and make sure that the minimum limit has a negative value and the maximum limit has a positive value.

Note: Default settings only allow forward direction.

1. Make sure that the control connections are wired according to the connection diagram given for the HVAC default. See section [Default control connections for the HVAC default on page 39](#).
2. Make sure that the drive is in external control. To switch to external control, press key . In external control, the panel display shows text **Auto** at the top left.

Starting and controlling the speed of the motor

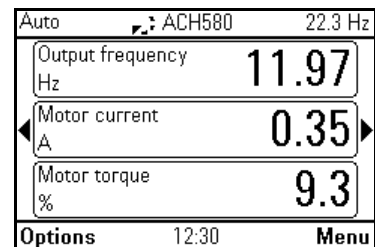

1. Start by switching digital input DI1 on. The arrow starts rotating. It is dotted until the setpoint is reached.
2. Regulate the drive output frequency (motor speed) by adjusting voltage of analog input AI1.





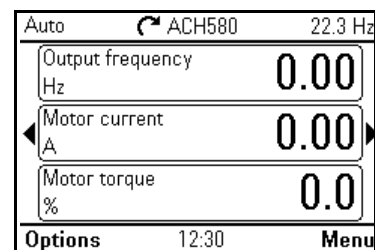





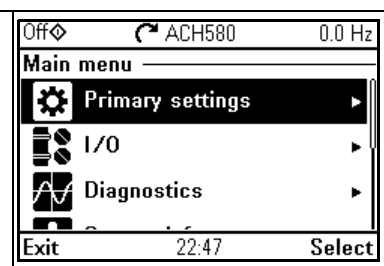



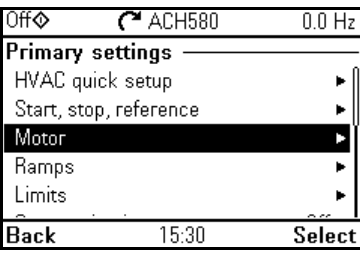



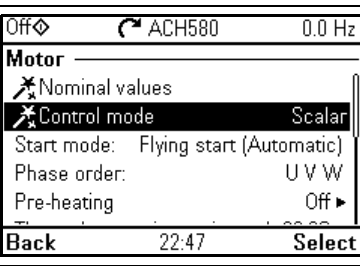

Stopping the motor

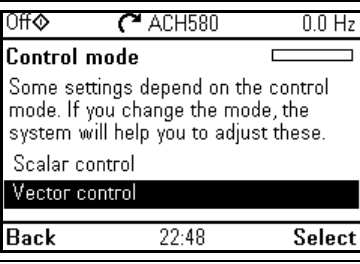
1. Switch digital input DI1 off. The arrow stops rotating.

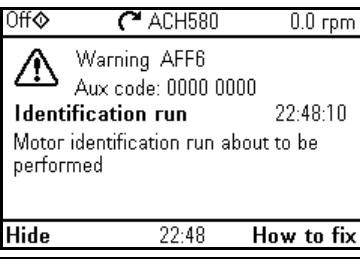

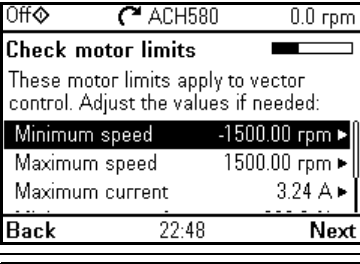
1 Go to the **Main** menu by pressing  (**Menu**) in the Home view.
Select **Primary settings** and press  (**Select**) (or ).

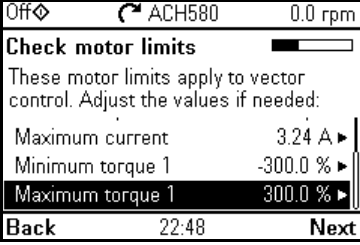

2	Select Motor and press  (Select) (or ).	 <p>Off  ACH580 0.0 Hz</p> <p>Primary settings</p> <ul style="list-style-type: none"> HVAC quick setup ▶ Start, stop, reference ▶ Motor ▶ Ramps ▶ Limits ▶ <p>Back 15:30 Select</p>
3	If the control modes is scalar, select Control mode and press  (Select) (or ) and continue to the next step.	 <p>Off  ACH580 0.0 Hz</p> <p>Motor</p> <ul style="list-style-type: none"> *Nominal values *Control mode Scalar Start mode: Flying start (Automatic) Phase order: U V W Pre-heating Off ▶ <p>Back 22:47 Select</p>
4	Select Vector control and press  (Select) (or )	 <p>Off  ACH580 0.0 Hz</p> <p>Control mode</p> <p>Some settings depend on the control mode. If you change the mode, the system will help you to adjust these.</p> <ul style="list-style-type: none"> Scalar control Vector control <p>Back 22:48 Select</p>
5	Warning message Identification run is shown for a moment.	 <p>Off  ACH580 0.0 rpm</p> <p> Warning AFF6 Aux code: 0000 0000</p> <p>Identification run 22:48:10</p> <p>Motor identification run about to be performed</p> <p>Hide 22:48 How to fix</p>
6	Check the motor speed limits. The following must be true: Minimum speed ≤ 0 rpm Maximum speed = motor rated speed.	 <p>Off  ACH580 0.0 rpm</p> <p>Check motor limits</p> <p>These motor limits apply to vector control. Adjust the values if needed:</p> <ul style="list-style-type: none"> Minimum speed -1500.00 rpm ▶ Maximum speed 1500.00 rpm ▶ Maximum current 3.24 A ▶ <p>Back 22:48 Next</p>
7	Check the motor current as well as torque limits. The following must be true: Maximum current $> I_{HD}$ Maximum torque $> 50\%$. press next	 <p>Off  ACH580 0.0 rpm</p> <p>Check motor limits</p> <p>These motor limits apply to vector control. Adjust the values if needed:</p> <ul style="list-style-type: none"> Maximum current 3.24 A ▶ Minimum torque 1 -300.0 % ▶ Maximum torque 1 300.0 % ▶ <p>Back 22:48 Next</p>

<p>8</p>	<p>Check AI1 scaling, see parameters 12.19 AI1 scaled at AI1 min and 12.20 AI1 scaled at AI1 max.</p>	
<p>9</p>	<p>Select the type of ID run you want to do and press (Select) (or).</p>	
<p>10</p>	<p>Check the motor limits shown on the panel. If you need other limits during the ID run you can enter them here. The originals limits will be restored after the ID run, unless you select Set values as permanent.</p>	
<p>11</p>	<p>Press the Hand key () to start the ID run. In general, it is recommended not to press any control panel keys during the ID run. However, you can stop the ID run at any time by pressing the Off key (). During the ID run a progress view is shown. After the ID run is completed, text ID run done is shown. The LED stops blinking. If the ID run fails, fault <i>FF61 ID run</i> is shown.</p>	
<p>12</p>	<p>After the ID run is completed, text Done is shown on row ID run.</p>	

Diagnostics

Warning Messages

Note: The list also contains events that only appear in the Event log.

Code (hex)	Warning / Aux. code	Cause	What to do
64FF	Fault reset	A fault has been reset from the panel, Drive composer PC tool, fieldbus or I/O.	Event. Informative only.
A2B1	Overcurrent	Output current has exceeded internal fault limit. In addition to an actual overcurrent situation, this warning may also be caused by an earth fault or supply phase loss.	<p>Check motor load.</p> <p>Check acceleration times in parameter group 23 <i>Speed reference ramp</i> (speed control) or 28 <i>Frequency reference chain</i> (frequency control). Also check parameters 46.01 <i>Speed scaling</i>, 46.02 <i>Frequency scaling</i> and 46.03 <i>Torque scaling</i>.</p> <p>Check motor and motor cable (including phasing and delta/star connection).</p> <p>Check for an earth fault in motor or motor cables by measuring the insulation resistances of motor and motor cable. See Checking the insulation of the assembly on page 16.</p> <p>Check there are no contactors opening and closing in motor cable.</p> <p>Check that the start-up data in parameter group 99 <i>Motor data</i> corresponds to the motor rating plate.</p> <p>Check that there are no power factor correction capacitors or surge absorbers in motor cable.</p>
A2B3	Earth leakage	Drive has detected load unbalance typically due to earth fault in motor or motor cable.	<p>Check there are no power factor correction capacitors or surge absorbers in motor cable.</p> <p>Check for an earth fault in motor or motor cables by measuring the insulation resistances of motor and motor cable. See Checking the insulation of the assembly on page 16. If an earth fault is found, fix or change the motor cable and/or motor.</p> <p>If no earth fault can be detected, contact your local ABB representative.</p>

Code (hex)	Warning / Aux. code	Cause	What to do
A2B4	Short circuit	Short-circuit in motor cable(s) or motor.	<p>Check motor and motor cable for cabling errors.</p> <p>Check motor and motor cable (including phasing and delta/star connection).</p> <p>Check for an earth fault in motor or motor cables by measuring the insulation resistances of motor and motor cable. See Checking the insulation of the assembly on page 16.</p> <p>Check there are no power factor correction capacitors or surge absorbers in motor cable.</p>
A2BA	IGBT overload	Excessive IGBT junction to case temperature. This warning protects the IGBT(s) and can be activated by a short circuit in the motor cable.	<p>Check motor cable.</p> <p>Check ambient conditions.</p> <p>Check air flow and fan operation.</p> <p>Check heatsink fins for dust pick-up.</p> <p>Check motor power against drive power.</p>
A3A1	DC link overvoltage	Intermediate circuit DC voltage too high (when the drive is stopped).	<p>Check the supply voltage setting (parameter <i>95.01 Supply voltage</i>). Note that the wrong setting of the parameter may cause the motor to rush uncontrollably, or may overload the brake chopper or resistor.</p> <p>Check the supply voltage.</p> <p>If the problem persists, contact your local ABB representative.</p>
A3A2	DC link undervoltage	Intermediate circuit DC voltage too low (when the drive is stopped).	
A3AA	DC not charged	The voltage of the intermediate DC circuit has not yet risen to operating level.	
A490	Incorrect temperature sensor setup	Temperature cannot be supervised due to incorrect adapter setup.	Check the settings of temperature source parameters <i>35.11</i> and <i>35.21</i> .
A491	External temperature 1 (Editable message text)	Measured temperature 1 has exceeded warning limit.	<p>Check the value of parameter <i>35.02 Measured temperature 1</i>.</p> <p>Check the cooling of the motor (or other equipment whose temperature is being measured).</p> <p>Check the value of <i>35.13 Temperature 1 warning limit</i>.</p>
A492	External temperature 2 (Editable message text)	Measured temperature 2 has exceeded warning limit.	<p>Check the value of parameter <i>35.03 Measured temperature 2</i>.</p> <p>Check the cooling of the motor (or other equipment whose temperature is being measured).</p> <p>Check the value of <i>35.23 Temperature 2 warning limit</i>.</p>
A4A0	Control board temperature	Control board temperature is too high.	Check the auxiliary code. See actions for each code below.

Code (hex)	Warning / Aux. code	Cause	What to do
	(none)	Temperature above warning limit	Check ambient conditions. Check air flow and fan operation. Check heatsink fins for dust pick-up.
	1	Thermistor broken	Contact an ABB service representative for control board replacement.
A4A1	IGBT overtemperature	Estimated drive IGBT temperature is excessive.	Check ambient conditions. Check air flow and fan operation. Check heatsink fins for dust pick-up. Check motor power against drive power.
A4A9	Cooling	Drive module temperature is excessive.	Check ambient temperature. If it exceeds 40 °C/104 °F (IP21 frames R4...R9) or if it exceeds 50 °C /122 °F (IP21 frames R1...R9), ensure that load current does not exceed derated load capacity of drive. For all P55 frames, check the derating temperatures. See chapter <i>Technical data</i> , section <i>Derating</i> in the <i>Hardware manual</i> of the drive. Check drive module cooling air flow and fan operation. Check inside of cabinet and heatsink of drive module for dust pick-up. Clean whenever necessary.
A4B0	Excess temperature	Power unit module temperature is excessive.	Check ambient conditions. Check air flow and fan operation. Check heatsink fins for dust pick-up. Check motor power against drive power.
A4B1	Excess temperature difference	High temperature difference between the IGBTs of different phases.	Check the motor cabling. Check cooling of drive module(s).
A4F6	IGBT temperature	Drive IGBT temperature is excessive.	Check ambient conditions. Check air flow and fan operation. Check heatsink fins for dust pick-up. Check motor power against drive power.
A581	Fan	Cooling fan feedback missing.	Check the auxiliary code to identify the fan. Code 0 denotes main fan 1. Other codes (format XYZ): "X" specifies state code (1 : ID run, 2 : normal). "Y" = 0, "Z" specifies the index of the fan (1 : Main fan 1, 2 : Main fan 2, 3 : Main fan 3). Check fan operation and connection. Replace fan if faulty.

Code (hex)	Warning / Aux. code	Cause	What to do
A582	Auxiliary fan missing	An auxiliary cooling fan (IP55 internal fan) is stuck or disconnected.	Check the auxiliary code. Check the auxiliary fan and connection. Replace faulty fan. Make sure the front cover of the drive is in place and tightened. If the commissioning of the drive requires that the cover is off, this warning will be generated even if the corresponding fault is defeated. See fault 5081 Auxiliary fan broken on page 71 .
A5A0	Safe torque off Programmable warning: <i>31.22 STO indication run/ stop</i>	Safe torque off function is active, ie safety circuit signal(s) connected to connector STO is lost.	Check safety circuit connections. For more information, chapter <i>The Safe torque off function</i> in the <i>Hardware manual</i> of the drive and description of parameter <i>31.22 STO indication run/ stop</i> in the Firmware manual. Check the value of parameter <i>95.04 Control board supply</i> .
A5EA	Measurement circuit temperature	Problem with internal temperature measurement of the drive.	Contact your local ABB representative.
A5EB	PU board powerfail	Power unit power supply failure.	Contact your local ABB representative.
A5ED	Measurement circuit ADC	Measurement circuit fault.	Contact your local ABB representative.
A5EE	Measurement circuit DFF	Measurement circuit fault.	Contact your local ABB representative.
A5EF	PU state feedback	State feedback from output phases does not match control signals.	Contact your local ABB representative.
A5F0	Charging feedback	Charging feedback signal missing.	Check the feedback signal coming from the charging system.
A682	Flash erase speed exceeded	The flash memory (in the memory unit) has been erased too frequently, compromising the lifetime of the memory.	Avoid forcing unnecessary parameter saves by parameter <i>96.07</i> or cyclic parameter writes (such as user logger triggering through parameters). Check the auxiliary code (format <i>XYYY YZZZ</i>). "X" specifies the source of warning (1 : generic flash erase supervision). "ZZZ" specifies the flash subsector number that generated the warning.
A6A4	Motor nominal value	The motor parameters are set incorrectly. The drive is not dimensioned correctly.	Check the auxiliary code. See actions for each code below.

Code (hex)	Warning / Aux. code	Cause	What to do
	0001	Slip frequency is too small.	Check the settings of the motor configuration parameters in groups 98 and 99. Check that the drive is sized correctly for the motor.
	0002	Synchronous and nominal speeds differ too much.	
	0003	Nominal speed is higher than synchronous speed with 1 pole pair.	
	0004	Nominal current is outside limits	
	0005	Nominal voltage is outside limits.	
	0006	Nominal power is higher than apparent power.	
	0007	Nominal power not consistent with nominal speed and torque.	
A6A5	No motor data	Parameters in group 99 have not been set.	Check that all the required parameters in group 99 have been set. Note: It is normal for this warning to appear during the start-up and continue until the motor data is entered.
A6A6	Voltage category unselected	The voltage category has not been defined.	Set voltage category in parameter <i>95.01 Supply voltage</i> .
A6A7	System time not set	System time is not set. Timed functions cannot be used and fault log dates are not correct.	Set the system time manually or connect the panel to the drive to synchronize the clock. If basic panel is used, synchronize the clock through the EFB or a fieldbus module. Set parameter <i>34.10 Timed functions enable</i> to <i>Not selected</i> to disable the timed functions if they are not used.
A6B0	User lock is open	The user lock is open, ie. user lock configuration parameters <i>96.100...96.102</i> are visible.	Close the user lock by entering an invalid pass code in parameter <i>96.02 Pass code</i> . See section <i>User lock</i> in the Firmware manual.
A6B1	User pass code not confirmed	A new user pass code has been entered in parameter <i>96.100</i> but not confirmed in <i>96.101</i> .	Confirm the new pass code by entering the same code in <i>96.101</i> . To cancel, close the user lock without confirming the new code. See section <i>User lock</i> in the Firmware manual
A6D1	FBA A parameter conflict	The drive does not have a functionality requested by a PLC, or requested functionality has not been activated.	Check PLC programming. Check settings of parameter groups <i>50 Fieldbus adapter (FBA)</i> .

Code (hex)	Warning / Aux. code	Cause	What to do
A6E5	AI parametrization	The current/voltage hardware setting of an analog input does not correspond to parameter settings.	Check the event log for an auxiliary code. The code identifies the analog input whose settings are in conflict. Adjust either the hardware setting (on the drive control unit) or parameter 12.15/12.25. Note: Control board reboot (either by cycling the power or through parameter 96.08 <i>Control board boot</i>) is required to validate any changes in the hardware settings.
A6E6	ULC configuration	User load curve configuration error.	Check the auxiliary code (format XXXX ZZZZ). "ZZZZ" indicates the problem (see actions for each code below).
	0000	Speed points inconsistent.	Check that each speed point (parameters 37.11...37.15) has a higher value than the previous point.
	0001	Frequency points inconsistent.	Check that each frequency point (37.20...37.16) has a higher value than the previous point.
	0002	Underload point above overload point.	Check that each overload point (37.31...37.35) has a higher value than the corresponding underload point (37.21...37.25).
	0003	Overload point below underload point.	
A780	Motor stall Programmable warning: 31.24 <i>Stall function</i>	Motor is operating in stall region because of e.g. excessive load or insufficient motor power.	Check motor load and drive ratings. Check fault function parameters.
A792	Brake resistor wiring	Brake resistor short circuit or brake chopper control fault. For drive frames R6 or larger.	Check brake chopper and brake resistor connection. Ensure brake resistor is not damaged.
A793	BR excess temperature	Brake resistor temperature has exceeded warning limit defined by parameter 43.12 <i>Brake resistor warning limit</i> .	Stop drive. Let resistor cool down. Check resistor overload protection function settings (parameter group 43 <i>Brake chopper</i>). Check warning limit setting, parameter 43.12 <i>Brake resistor warning limit</i> . Check that the resistor has been dimensioned correctly. Check that braking cycle meets allowed limits.
A794	BR data	Brake resistor data has not been given.	One or more of the resistor data settings (parameters 43.08...43.10) is incorrect. The parameter is specified by the auxiliary code.
	0000 0001	Resistance value too low.	Check value of 43.10.
	0000 0002	Thermal time constant not given.	Check value of 43.08.

Code (hex)	Warning / Aux. code	Cause	What to do
	0000 0003	Maximum continuous power not given.	Check value of 43.09.
A79C	BC IGBT excess temperature	Brake chopper IGBT temperature has exceeded internal warning limit.	Let chopper cool down. Check for excessive ambient temperature. Check for cooling fan failure. Check for obstructions in the air flow. Check the dimensioning and cooling of the cabinet. Check resistor overload protection function settings (parameters 43.06...43.10). Check minimum allowed resistor value for the chopper being used. Check that braking cycle meets allowed limits. Check that drive supply AC voltage is not excessive.
A7AB	Extension I/O configuration failure	Installed CMOD module is not the same as configured.	Check that the installed module (shown by parameter 15.02 <i>Detected extension module</i>) is the same as selected by parameter 15.01 <i>Extension module type</i> .
A7C1	FBA A communication Programmable warning: 50.02 <i>FBA A comm loss func</i>	Cyclical communication between drive and fieldbus adapter module A or between PLC and fieldbus adapter module A is lost.	Check status of fieldbus communication. See user documentation of fieldbus interface. Check settings of parameter groups 50 <i>Fieldbus adapter (FBA)</i> , 51 <i>FBA A settings</i> , 52 <i>FBA A data in</i> and 53 <i>FBA A data out</i> . Check cable connections. Check if communication master is able to communicate.
A7CE	EFB comm loss Programmable warning: 58.14 <i>Communication loss action</i>	Communication break in embedded fieldbus (EFB) communication.	Check the status of the fieldbus master (online/offline/error etc.). Check cable connections to the EIA-485/X5 terminals 29, 30 and 31 on the control unit.
A7EE	Panel loss Programmable warning: 49.05 <i>Communication loss action</i>	Control panel or PC tool selected as active control location for drive has ceased communicating.	Check PC tool or control panel connection. Check control panel connector. Check mounting platform if being used. Disconnect and reconnect the control panel.
A88F	Cooling fan	Maintenance timer limit exceeded.	Consider changing the cooling fan. Parameter 05.04 <i>Fan on-time counter</i> shows the running time of the cooling fan.

Code (hex)	Warning / Aux. code	Cause	What to do
A8A0	AI supervision Programmable warning: <i>12.03 AI supervision function</i>	An analog signal is outside the limits specified for the analog input.	Check signal level at the analog input. Check the wiring connected to the input. Check the minimum and maximum limits of the input in parameter group <i>12 Standard AI</i> .
A8A1	RO life warning	The relay has changed states more than the recommended number of times.	Change the control board or stop using the relay output.
	0001	Relay output 1	Change the control board or stop using relay output 1.
	0002	Relay output 2	Change the control board or stop using relay output 2.
	0003	Relay output 3	Change the control board or stop using relay output 3.
A8A2	RO toggle warning	The relay output is changing states faster than recommended, eg. if a fast changing frequency signal is connected to it. The relay lifetime will be exceeded shortly.	Replace the signal connected to the relay output source with a less frequently changing signal.
	0001	Relay output 1	Select a different signal with parameter <i>10.24 RO1 source</i> .
	0002	Relay output 2	Select a different signal with parameter <i>10.27 RO2 source</i> .
	0003	Relay output 3	Select a different signal with parameter <i>10.30 RO3 source</i> .
A8B0	ABB Signal supervision 1 (Editable message text) Programmable warning: <i>32.06 Supervision 1 action</i>	Warning generated by the signal supervision function 1.	Check the source of the warning (parameter <i>32.07 Supervision 1 signal</i>).
A8B1	ABB Signal supervision 2 (Editable message text) Programmable warning: <i>32.16 Supervision 2 action</i>	Warning generated by the signal supervision function 2.	Check the source of the warning (parameter <i>32.17 Supervision 2 signal</i>).
A8B2	ABB Signal supervision 3 (Editable message text) Programmable warning: <i>32.26 Supervision 3 action</i>	Warning generated by the signal supervision function 3.	Check the source of the warning (parameter <i>32.27 Supervision 3 signal</i>).
A8B3	ABB Signal supervision 4 (Editable message text) Programmable warning: <i>32.36 Supervision 4 action</i>	Warning generated by the signal supervision function 4.	Check the source of the warning (parameter <i>32.37 Supervision 4 signal</i>).
A8B4	ABB Signal supervision 5 (Editable message text) Programmable warning: <i>32.46 Supervision 5 action</i>	Warning generated by the signal supervision function 5.	Check the source of the warning (parameter <i>32.47 Supervision 5 signal</i>).

Code (hex)	Warning / Aux. code	Cause	What to do
A8B5	ABB Signal supervision 6 (Editable message text) Programmable warning: <i>32.56 Supervision 6 action</i>	Warning generated by the signal supervision function 6.	Check the source of the warning (parameter <i>32.57 Supervision 6 signal</i>).
A8BE	ULC overload warning Programmable fault: <i>37.03 ULC overload actions</i>	Selected signal has exceeded the user overload curve.	Check for any operating conditions increasing the monitored signal (for example, the loading of the motor if the torque or current is being monitored). Check the definition of the load curve (parameter group <i>37 User load curve</i>).
A8BF	ULC underload warning Programmable fault: <i>37.04 ULC underload actions</i>	Selected signal has fallen below the user underload curve.	Check for any operating conditions decreasing the monitored signal (for example, loss of load if the torque or current is being monitored). Check the definition of the load curve (parameter group <i>37 User load curve</i>).
A981	External warning 1 (Editable message text) Programmable warning: <i>31.01 External event 1 source</i> <i>31.02 External event 1 type</i>	Fault in external device 1.	Check the external device. Check setting of parameter <i>31.01 External event 1 source</i> .
A982	External warning 2 (Editable message text) Programmable warning: <i>31.03 External event 2 source</i> <i>31.04 External event 2 type</i>	Fault in external device 2.	Check the external device. Check setting of parameter <i>31.03 External event 2 source</i> .
A983	External warning 3 (Editable message text) Programmable warning: <i>31.05 External event 3 source</i> <i>31.06 External event 3 type</i>	Fault in external device 3.	Check the external device. Check setting of parameter <i>31.05 External event 3 source</i> .
A984	External warning 4 (Editable message text) Programmable warning: <i>31.07 External event 4 source</i> <i>31.08 External event 4 type</i>	Fault in external device 4.	Check the external device. Check setting of parameter <i>31.07 External event 4 source</i> .

Code (hex)	Warning / Aux. code	Cause	What to do
A985	External warning 5 (Editable message text) Programmable warning: <i>31.09 External event 5 source</i> <i>31.10 External event 5 type</i>	Fault in external device 5.	Check the external device. Check setting of parameter <i>31.09 External event 5 source</i> .
AF80	INU-LSU comm loss Programmable warning: <i>60.79 INU-LSU comm loss function</i>	DDCS (fiber optic) communication between converters (for example, the inverter unit and the supply unit) is lost. Note that the inverter unit will continue operating based on the status information that was last received from the other converter.	Check status of other converter (parameters <i>06.36</i> and <i>06.39</i>). Check settings of parameter group <i>60 DDCS communication</i> . Check the corresponding settings in the control program of the other converter. Check cable connections. If necessary, replace cables.
AF85	Line side unit warning	The supply unit (or other converter) has generated a warning.	The auxiliary code specifies the original warning code in the supply unit control program. See chapter <i>Fault tracing</i> in the ACH580 HVAC control program firmware manual , publication number 3AXD5000027537 .
AF88	Season configuration warning	You have configured a season which starts before the previous season.	Configure the seasons with increasing start dates, see parameters <i>34.60 Season 1 start date...34.63 Season 4 start date</i> .
AF8C	Process PID sleep mode	The drive is entering sleep mode.	Informative warning. See section <i>Sleep and boost functions for process PID control</i> , and parameters <i>40.43...40.48</i> in the Firmware manual
AFAA	Autoreset	A fault is about to be autoreset.	Informative warning. See the settings in parameter group <i>31 Fault functions</i> .
AFE1	Emergency stop (off2)	Drive has received an emergency stop (mode selection off2) command.	Check that it is safe to continue operation. Then return emergency stop push button to normal position. Restart drive.
AFE2	Emergency stop (off1 or off3)	Drive has received an emergency stop (mode selection off1 or off3) command.	If the emergency stop was unintentional, check the source selected by parameter <i>21.05 Emergency stop source</i> .
AFE9	Start delay	The start delay is active and the drive will start the motor after a predefined delay.	Informative warning. See parameter <i>21.22 Start delay</i> .
AFED	Run permissive	Run permissive is keeping the drive from running the motor.	Check the setting of (and source selected by) parameter <i>20.40 Run permissive</i> .
AFEE	Start interlock 1	Start interlock 1 is keeping the drive from starting.	Check the signal source selected for parameter <i>20.41 Start interlock 1</i> .

Code (hex)	Warning / Aux. code	Cause	What to do
AFEF	Start interlock 2	Start interlock 2 is keeping the drive from starting.	Check the signal source selected for parameter 20.42 <i>Start interlock 2</i> .
AFF0	Start interlock 3	Start interlock 3 is keeping the drive from starting.	Check the signal source selected for parameter 20.43 <i>Start interlock 3</i> .
AFF1	Start interlock 4	Start interlock 4 is keeping the drive from starting.	Check the signal source selected for parameter 20.44 <i>Start interlock 4</i> .
AFF5	Override new start required	The Safe torque off function was active and has been reset while in Override.	A new start signal is required to start the drive again.
AFF6	Identification run	Motor ID run will occur at next start.	Informative warning.
AFF8	Motor heating active	Pre-heating is being performed	Informative warning. Motor pre-heating is active. Current specified by parameter 21.16 <i>Pre-heating current</i> is being passed through the motor.
AFFE	Override active	Drive is in override mode.	Informative warning.
B5A0	STO event Programmable event: 31.22 <i>STO indication run/stop</i>	Safe torque off function is active, ie. safety circuit signal(s) connected to connector STO is lost.	Informative warning. Check safety circuit connections. For more information, see chapter <i>The Safe torque off function</i> in the <i>Hardware manual</i> of the drive and parameter 31.22 <i>STO indication run/stop</i> .
D501	No more available PFC motors	No more PFC motors can be started because they can be interlocked or in the Hand mode.	Check that there are no interlocked PFC motors, see parameters: 76.81...76.84. If all motors are in use, the PFC system is not adequately dimensioned to handle the demand.
D502	All motors interlocked	All the motors in the PFC system are interlocked.	Check that there are no interlocked PFC motors, see parameters 76.81...76.84.
D503	VSD controlled PFC motor interlocked	The motor connected to the drive is interlocked (unavailable).	Motor connected to the drive is interlocked and thus cannot be started. Remove the corresponding interlock to start the drive controlled PFC motor. See parameters 76.81...76.84.

Fault messages

Code (hex)	Fault / Aux. code	Cause	What to do
1080	Backup/Restore timeout	Panel or PC tool has failed to communicate with the drive when backup was being made or restored.	Request backup or restore again.
1081	Rating ID fault	Drive software has not been able to read the rating ID of the drive.	Reset the fault to make the drive try to reread the rating ID. If the fault reappears, cycle the power to the drive. You may have to be repeat this. If the fault persists, contact your local ABB representative.
2310	Overcurrent	Output current has exceeded internal fault limit. In addition to an actual overcurrent situation, this fault may also be caused by an earth fault or supply phase loss.	Check motor load. Check acceleration times in parameter group 23 <i>Speed reference ramp</i> (speed control) or 28 <i>Frequency reference chain</i> (frequency control). Also check parameters 46.01 <i>Speed scaling</i> , 46.02 <i>Frequency scaling</i> and 46.03 <i>Torque scaling</i> . Check motor and motor cable (including phasing and delta/star connection). Check there are no contactors opening and closing in motor cable. Check that the start-up data in parameter group 99 corresponds to the motor rating plate. Check that there are no power factor correction capacitors or surge absorbers in motor cable. Check for an earth fault in motor or motor cables by measuring the insulation resistances of motor and motor cable. See Checking the insulation of the assembly on page 16 .
2330	Earth leakage Programmable fault: 31.20 <i>Earth fault</i>	Drive has detected load unbalance typically due to earth fault in motor or motor cable.	Check there are no power factor correction capacitors or surge absorbers in motor cable. Check for an earth fault in motor or motor cables by measuring the insulation resistances of motor and motor cable. Try running the motor in scalar control mode if allowed. (See parameter 99.04 <i>Motor control mode</i> .) If no earth fault can be detected, contact your local ABB representative.

Code (hex)	Fault / Aux. code	Cause	What to do
2340	Short circuit	Short-circuit in motor cable(s) or motor	Check motor and motor cable for cabling errors. Check there are no power factor correction capacitors or surge absorbers in motor cable. Cycle the power to the drive.
2381	IGBT overload	Excessive IGBT junction to case temperature. This fault protects the IGBT(s) and can be activated by a short circuit in the motor cable.	Check motor cable. Check ambient conditions. Check air flow and fan operation. Check heatsink fins for dust pick-up. Check motor power against drive power.
3130	Input phase loss Programmable fault: 31.21 <i>Supply phase loss</i>	Intermediate circuit DC voltage is oscillating due to missing input power line phase or blown fuse.	Check input power line fuses. Check for loose power cable connections. Check for input power supply imbalance.
3181	Wiring or earth fault Programmable fault: 31.23 <i>Wiring or earth fault</i>	Incorrect input power and motor cable connection (ie. input power cable is connected to drive motor connection).	Check input power connections.
3210	DC link overvoltage	Excessive intermediate circuit DC voltage.	Check that overvoltage control is on (parameter 30.30 <i>Overvoltage control</i>). Check that the supply voltage matches the nominal input voltage of the drive. Check the supply line for static or transient overvoltage. Check brake chopper and resistor (if present). Check deceleration time. Use coast-to-stop function (if applicable). Retrofit drive with brake chopper and brake resistor. Check that the brake resistor is dimensioned properly and the resistance is between acceptable range for the drive.
3220	DC link undervoltage	Intermediate circuit DC voltage is not sufficient because of a missing supply phase, blown fuse or fault in the rectifier bridge.	Check supply cabling, fuses and switchgear.
3381	Output phase loss Programmable fault: 31.19 <i>Motor phase loss</i>	Motor circuit fault due to missing motor connection (all three phases are not connected).	Connect motor cable.

Code (hex)	Fault / Aux. code	Cause	What to do
4110	Control board temperature	Control board temperature is too high.	Check proper cooling of the drive. Check the auxiliary cooling fan.
4210	IGBT overtemperature	Estimated drive IGBT temperature is excessive.	Check ambient conditions. Check air flow and fan operation. Check heatsink fins for dust pick-up. Check motor power against drive power.
4290	Cooling	Drive module temperature is excessive.	Check ambient temperature. If it exceeds 40 °C/104 °F (IP21 frames R4...R9) or if it exceeds 50 °C /122 °F (IP21 frames R1...R9), ensure that load current does not exceed derated load capacity of drive. For all P55 frames, check the derating temperatures. See chapter <i>Technical data</i> , section <i>Derating</i> in the <i>Hardware manual</i> of the drive. Check drive module cooling air flow and fan operation. Check inside of cabinet and heatsink of drive module for dust pick-up. Clean whenever necessary.
42F1	IGBT temperature	Drive IGBT temperature is excessive.	Check ambient conditions. Check air flow and fan operation. Check heatsink fins for dust pick-up. Check motor power against drive power.
4310	Excess temperature	Power unit module temperature is excessive.	Check ambient conditions. Check air flow and fan operation. Check heatsink fins for dust pick-up. Check motor power against drive power.
4380	Excess temperature difference	High temperature difference between the IGBTs of different phases.	Check the motor cabling. Check cooling of drive module(s).
4981	External temperature 1 (Editable message text)	Measured temperature 1 has exceeded fault limit.	Check the value of parameter 35.02 <i>Measured temperature 1</i> . Check the cooling of the motor (or other equipment whose temperature is being measured).
4982	External temperature 2 (Editable message text)	Measured temperature 2 has exceeded fault limit.	Check the value of parameter 35.03 <i>Measured temperature 2</i> . Check the cooling of the motor (or other equipment whose temperature is being measured).
5080	Fan	Cooling fan feedback missing.	See A581 Fan (page 59).

Code (hex)	Fault / Aux. code	Cause	What to do
5081	Auxiliary fan broken	An auxiliary cooling fan (connected to the fan connectors on the control unit) is stuck or disconnected.	Check the auxiliary code. Check auxiliary fan(s) and connection(s). Replace fan if faulty. Make sure the front cover of the drive is in place and tightened. If the commissioning of the drive requires th the cover is off, activate parameter <i>31.36 Aux fan fault bybass</i> within 2 min from control unit reboot to temporarily suppress the fault. Reboot the control unit (using parameter <i>96.08 Control board boot</i>) or by cycling power.
	0001	Auxiliary fan 1 broken.	
	0002	Auxiliary fan 2 broken.	
5090	STO hardware failure	STO hardware diagnostics has detected hardware failure.	Contact your local ABB representative for hardware replacement.
5091	Safe torque off Programmable fault: <i>31.22 STO indication run/stop</i>	Safe torque off function is active, ie. safety circuit signal(s) connected to connector STO is broken during start or run.	Check safety circuit connections. For more information, see chapter <i>The Safe torque off function</i> in the <i>Hardware manual</i> of the drive and parameter <i>31.22 STO indication run/stop</i> . Check the value of parameter <i>95.04 Control board supply</i> .
5092	PU logic error	Power unit memory has cleared.	Contact your local ABB representative.
5093	Rating ID mismatch	The hardware of the drive does not match the information stored in the memory. This may occur eg. after a firmware update.	Cycle the power to the drive. You may have to be repeat this.
5094	Measurement circuit temperature	Problem with internal temperature measurement of the drive.	Contact your local ABB representative.
5098	I/O communication loss	Internal standard I/O communication failure.	Try resetting the fault or reboot the drive.
50A0	Fan	Cooling fan stuck or disconnected.	Check fan operation and connection. Replace fan if faulty.
5682	Power unit lost	Connection between the drive control unit and the power unit is lost.	Check the connection between the control unit and the power unit.
5691	Measurement circuit ADC	Measurement circuit fault.	Contact your local ABB representative.
5692	PU board powerfail	Power unit power supply failure.	Contact your local ABB representative.

Code (hex)	Fault / Aux. code	Cause	What to do
5693	Measurement circuit DFF	Measurement circuit fault.	Contact your local ABB representative.
5696	PU state feedback	State feedback from output phases does not match control signals.	Contact your local ABB representative.
5697	Charging feedback	Charging feedback signal missing.	Check the feedback signal coming from the charging system.
5698	Unknown PU fault	The power unit logic has generated a fault which is not known by the software.	Check the logic and software compatibility.
6181	FPGA version incompatible	Firmware and FPGA versions are incompatible.	Reboot the control unit (using parameter <i>96.08 Control board boot</i>) or by cycling power. If the problem persists, contact your local ABB representative.
6306	FBA A mapping file	Fieldbus adapter A mapping file read error.	Contact your local ABB representative.
6481	Task overload	Internal fault.	Reboot the control unit (using parameter <i>96.08 Control board boot</i>) or by cycling power. If the problem persists, contact your local ABB representative.
6487	Stack overflow	Internal fault.	Reboot the control unit (using parameter <i>96.08 Control board boot</i>) or by cycling power. If the problem persists, contact your local ABB representative.
64A1	Internal file load	File read error.	Reboot the control unit (using parameter <i>96.08 Control board boot</i>) or by cycling power. If the problem persists, contact your local ABB representative.
64A4	Rating ID fault	Rating ID load error.	Contact your local ABB representative.
64A6	Adaptive program	Error running the adaptive program.	Check the auxiliary code (format <i>XXYY ZZZZ</i>). "XX" specifies the number of the state (00=base program) and "YY" specifies the number of the function block (0000=generic error). "ZZZZ" indicates the problem.
	000A	Program corrupted or block non-existent	Restore the template program or download the program to the drive.
	000C	Required block input missing	Check the inputs of the block.
	000E	Program corrupted or block non-existent	Restore the template program or download the program to the drive.
	0011	Program too large.	Remove blocks until the error stops.
	0012	Program is empty.	Correct the program and download it to the drive.

Code (hex)	Fault / Aux. code	Cause	What to do
	001C	A non-existing parameter or block is used in the program.	Edit the program to correct the parameter reference, or to use an existing block.
	001D	Parameter type invalid for selected pin.	Edit the program to correct the parameter reference.
	001E	Output to parameter failed because the parameter was write-protected.	Check the parameter reference in the program. Check for other sources affecting the target parameter.
	0023	Program file incompatible with current firmware version.	Adapt the program to current block library and firmware version.
	0024		
	Other	–	Contact your local ABB representative, quoting the auxiliary code.
64B1	Internal SSW fault	Internal fault.	Reboot the control unit (using parameter <i>96.08 Control board boot</i>) or by cycling power. If the problem persists, contact your local ABB representative.
64B2	User set fault	<p>Loading of user parameter set failed because</p> <ul style="list-style-type: none"> • requested set does not exist • set is not compatible with control program • drive was switched off during loading. 	Ensure that a valid user parameter set exists. Reload if uncertain.
64E1	Kernel overload	Operating system error.	Reboot the control unit (using parameter <i>96.08 Control board boot</i>) or by cycling power. If the problem persists, contact your local ABB representative.
64B1	Fault reset	A fault has been reset. The cause of the fault no longer exists and the fault reset has been requested and completed.	Informative fault.
6581	Parameter system	Parameter load or save failed.	Try forcing a save using parameter <i>96.07 Parameter save manually</i> . Retry.
6591	Backup/Restore timeout	During backup creating or restoring operation a panel or PC-tool has failed to communicate with the drive as part this operation.	Check panel or PC-tool communication and if it is still in backup or restore state.

Code (hex)	Fault / Aux. code	Cause	What to do
65A1	FBA A parameter conflict	The drive does not have a functionality requested by PLC, or requested functionality has not been activated.	Check PLC programming. Check settings of parameter groups <i>50 Fieldbus adapter (FBA)</i> and <i>51 FBA A settings</i> .
6681	EFB comm loss Programmable fault: <i>58.14 Communication loss action</i>	Communication break in embedded fieldbus (EFB) communication.	Check the status of the fieldbus master (online/offline/error etc.). Check cable connections to the EIA-485/X5 terminals 29, 30 and 31 on the control unit.
6682	EFB config file	Embedded fieldbus (EFB) configuration file could not be read.	Contact your local ABB representative.
6683	EFB invalid parameterization	Embedded fieldbus (EFB) parameter settings inconsistent or not compatible with selected protocol.	Check the settings in parameter group <i>58 Embedded fieldbus</i> .
6684	EFB load fault	Embedded fieldbus (EFB) protocol firmware could not be loaded.	Contact your local ABB representative.
		Version mismatch between EFB protocol firmware and drive firmware.	
6685	EFB fault 2	Fault reserved for the EFB protocol application.	Check the documentation of the protocol.
6686	EFB fault 3	Fault reserved for the EFB protocol application.	Check the documentation of the protocol.
6882	Text 32-bit table overflow	Internal fault.	Reset the fault. Contact your local ABB representative if the fault persists.
6885	Text file overflow	Internal fault.	Reset the fault. Contact your local ABB representative if the fault persists.
7081	Control panel loss Programmable fault: <i>49.05 Communication loss action</i>	Control panel or PC tool selected as active control location for drive has ceased communicating.	Check PC tool or control panel connection. Check control panel connector. Disconnect and reconnect the control panel.
7085	Incompatible option module	Fieldbus option module not supported.	Replace the module with a supported type.
7100	Excitation current	Excitation current feedback low or missing	
7121	Motor stall Programmable fault: <i>31.24 Stall function</i>	Motor is operating in stall region because of e.g. excessive load or insufficient motor power.	Check motor load and drive ratings. Check fault function parameters.

Code (hex)	Fault / Aux. code	Cause	What to do
7181	Brake resistor	Brake resistor broken or not connected.	Check that a brake resistor has been connected. Check the condition of the brake resistor. Check the dimensioning of the brake resistor.
7183	BR excess temperature	Brake resistor temperature has exceeded fault limit defined by parameter <i>43.11 Brake resistor fault limit</i> .	Stop drive. Let resistor cool down. Check resistor overload protection function settings (parameter group <i>43 Brake chopper</i>). Check fault limit setting, parameter <i>43.11 Brake resistor fault limit</i> . Check that braking cycle meets allowed limits.
7184	Brake resistor wiring	Brake resistor short circuit or brake chopper control fault.	Check brake chopper and brake resistor connection. Ensure brake resistor is not damaged.
7191	BC short circuit	Short circuit in brake chopper IGBT.	Ensure brake resistor is connected and not damaged. Check the electrical specifications of the brake resistor against chapter <i>Resistor braking</i> in the <i>Hardware manual</i> of the drive. Replace brake chopper (if replaceable).
7192	BC IGBT excess temperature	Brake chopper IGBT temperature has exceeded internal fault limit.	Let chopper cool down. Check for excessive ambient temperature. Check for cooling fan failure. Check for obstructions in the air flow. Check resistor overload protection function settings (parameter group <i>43 Brake chopper</i>). Check that braking cycle meets allowed limits. Check that drive supply AC voltage is not excessive.
7310	Overspeed	Motor is turning faster than highest allowed speed due to incorrectly set minimum/maximum speed, insufficient braking torque or changes in load when using torque reference.	Check minimum/maximum speed settings, parameters <i>30.11 Minimum speed</i> and <i>30.12 Maximum speed</i> . Check adequacy of motor braking torque. Check applicability of torque control. Check need for brake chopper and resistor(s).
73F0	Overfrequency	Maximum allowed output frequency exceeded.	Contact your local ABB representative.

Code (hex)	Fault / Aux. code	Cause	What to do
73B0	Emergency ramp failed	Emergency stop did not finish within expected time.	Check the settings of parameters <i>31.32 Emergency ramp supervision</i> and <i>31.33 Emergency ramp supervision delay</i> . Check the predefined ramp times (<i>23.11...23.15</i> for mode Off1, <i>23.23</i> for mode Off3).
7510	FBA A communication Programmable fault: <i>50.02 FBA A comm loss func</i>	Cyclical communication between drive and fieldbus adapter module A or between PLC and fieldbus adapter module A is lost.	Check status of fieldbus communication. See user documentation of fieldbus interface. Check settings of parameter groups <i>50 Fieldbus adapter (FBA)</i> , <i>51 FBA A settings</i> , <i>52 FBA A data in</i> and <i>53 FBA A data out</i> . Check cable connections. Check if communication master is able to communicate.
7580	INU-LSU comm loss Programmable fault: <i>60.79 INU-LSU comm loss function</i>	DDCS communication between the inverter unit and the supply unit is lost.	Check status of the supply unit (parameter group <i>06 Control and status words</i>). Check settings of parameter group <i>60 DDCS communication</i> . Check the corresponding settings in the control program of the supply unit. Check cable connections. If necessary, replace cables.
7583	Line side unit faulted	The supply unit connected to the inverter unit has generated a fault.	The auxiliary code specifies the original fault code in the supply unit control program. See chapter <i>Fault tracing</i> in the <i>ACH580 HVAC control program firmware manual</i> , publication number <i>3AXD50000027537</i> .
7584	LSU charge failed	The supply unit was not ready (ie. the main contactor/breaker could not be closed) within expected time.	Check settings of parameter <i>94.10 LSU max charging time</i> . Check that parameter <i>60.71 INU-LSU communication port</i> is set to <i>DDCS via BC</i> . Check that the supply unit is enabled, allowed to start, and can be controlled by the inverter unit (eg. not in local control mode).
8001	ULC underload fault	User load curve: Signal has been too long under the underload curve.	See parameter <i>37.04 ULC underload actions</i> .
8002	ULC overload fault	User load curve: Signal has been too long over the overload curve.	See parameter <i>37.03 ULC overload actions</i> .

Code (hex)	Fault / Aux. code	Cause	What to do
80A0	AI supervision Programmable fault: <i>12.03 AI supervision function</i>	An analog signal is outside the limits specified for the analog input.	Check signal level at the analog input. Check the auxiliary code. Check the wiring connected to the input. Check the minimum and maximum limits of the input in parameter group <i>12 Standard AI</i> .
	0001	AI1LessMIN	
	0002	AI1GreaterMAX	
	0003	AI2LessMIN.	
	0004	AI2GreaterMAX	
80B0	Signal supervision 1 (Editable message text) Programmable fault: <i>32.06 Supervision 1 action</i>	Fault generated by the signal supervision function 1.	Check the source of the fault (parameter <i>32.07 Supervision 1 signal</i>).
80B1	Signal supervision 2 (Editable message text) Programmable fault: <i>32.16 Supervision 2 action</i>	Fault generated by the signal supervision function 2.	Check the source of the fault (parameter <i>32.17 Supervision 2 signal</i>).
80B2	Signal supervision 3 (Editable message text) Programmable fault: <i>32.26 Supervision 3 action</i>	Fault generated by the signal supervision function 3.	Check the source of the fault (parameter <i>32.27 Supervision 3 signal</i>).
80B3	Signal supervision 4 (Editable message text) Programmable fault: <i>32.36 Supervision 4 action</i>	Fault generated by the signal supervision function 4.	Check the source of the fault (parameter <i>32.37 Supervision 4 signal</i>).
80B4	Signal supervision 5 (Editable message text) Programmable fault: <i>32.46 Supervision 5 action</i>	Fault generated by the signal supervision function 5.	Check the source of the fault (parameter <i>32.47 Supervision 5 signal</i>).
80B5	Signal supervision 6 (Editable message text) Programmable fault: <i>32.56 Supervision 6 action</i>	Fault generated by the signal supervision function 6.	Check the source of the fault (parameter <i>32.57 Supervision 6 signal</i>).
9081	External fault 1 (Editable message text) Programmable fault: <i>31.01 External event 1 source</i> <i>31.02 External event 1 type</i>	Fault in external device 1.	Check the external device. Check setting of parameter <i>31.01 External event 1 source</i> .
9082	External fault 2 (Editable message text) Programmable fault: <i>31.03 External event 2 source</i> <i>31.04 External event 2 type</i>	Fault in external device 2.	Check the external device. Check setting of parameter <i>31.03 External event 2 source</i> .

Code (hex)	Fault / Aux. code	Cause	What to do
9083	External fault 3 (Editable message text) Programmable fault: 31.05 <i>External event 3 source</i> 31.06 <i>External event 3 type</i>	Fault in external device 3.	Check the external device. Check setting of parameter 31.05 <i>External event 3 source</i> .
9084	External fault 4 (Editable message text) Programmable fault: 31.07 <i>External event 4 source</i> 31.08 <i>External event 4 type</i>	Fault in external device 4.	Check the external device. Check setting of parameter 31.07 <i>External event 4 source</i> .
9085	External fault 5 (Editable message text) Programmable fault: 31.09 <i>External event 5 source</i> 31.10 <i>External event 5 type</i>	Fault in external device 5.	Check the external device. Check setting of parameter 31.09 <i>External event 5 source</i> .
FA81	Safe torque off 1	Safe torque off function is active, ie. STO circuit 1 is broken.	Check safety circuit connections. For more information, see chapter <i>The Safe torque off function</i> in the <i>Hardware manual</i> of the drive and parameter 31.22 <i>STO indication run/stop</i> . Check the value of parameter 95.04 <i>Control board supply</i> .
FA82	Safe torque off 2	Safe torque off function is active, ie. STO circuit 2 is broken.	
FF61	ID run	Motor ID run was not completed successfully.	Check the nominal motor values in parameter group 99 <i>Motor data</i> . Check that no external control system is connected to the drive. Cycle the power to the drive (and its control unit, if powered separately). Check that no operation limits prevent the completion of the ID run. Restore parameters to default settings and try again. Check that the motor shaft is not locked. Check the auxiliary code. The second number of the code indicates the problem (see actions for each code below).
	0001	Maximum current limit too low.	Check settings of parameters 99.06 <i>Motor nominal current</i> and 30.17 <i>Maximum current</i> . Make sure that 30.17 > 99.06. Check that the drive is dimensioned correctly according to the motor.

Code (hex)	Fault / Aux. code	Cause	What to do
	0002	Maximum speed limit or calculated field weakening point too low.	Check settings of parameters <i>30.11 Minimum speed</i> <i>30.12 Maximum speed</i> <i>99.07 Motor nominal voltage</i> <i>99.08 Motor nominal frequency</i> <i>99.09 Motor nominal speed.</i> Make sure that $30.12 > (0.55 \times 99.09) > (0.50 \times \text{synchronous speed})$ $30.11 \leq 0$, and supply voltage $\geq (0.66 \times 99.07)$.
	0003	Maximum torque limit too low.	Check settings of parameter <i>99.12 Motor nominal torque</i> , and the torque limits in group <i>30 Limits</i> . Make sure that the maximum torque limit in force is greater than 100%.
	0004	Current measurement calibration did not finish within reasonable time	Contact your local ABB representative.
	0005...0008	Internal error.	Contact your local ABB representative.
	0009	(Asynchronous motors only) Acceleration did not finish within reasonable time.	Contact your local ABB representative.
	000A	(Asynchronous motors only) Deceleration did not finish within reasonable time.	Contact your local ABB representative.
	000B	(Asynchronous motors only) Speed dropped to zero during ID run.	Contact your local ABB representative.
	000C	(Permanent magnet motors only) First acceleration did not finish within reasonable time.	Contact your local ABB representative.
	000D	(Permanent magnet motors only) Second acceleration did not finish within reasonable time.	Contact your local ABB representative.
	000E...0010	Internal error.	Contact your local ABB representative.
	0011	(Synchronous reluctance motors only) Pulse test error.	Contact your local ABB representative.

Code (hex)	Fault / Aux. code	Cause	What to do
	0012	Motor too large for advanced standstill ID run.	Check that the motor and drive sizes are compatible. Contact your local ABB representative.
	0013	(Asynchronous motors only) Motor data error.	Check that the motor nominal value settings in the drive are the same as in the motor nameplate. Contact your local ABB representative.
FF63	STO diagnostics failure.	SW internal malfunction.	Reboot the control unit (using parameter <i>96.08 Control board boot</i>) or by cycling power.
FF81	FB A force trip	A fault trip command has been received through fieldbus adapter A.	Check the fault information provided by the PLC.
FF8E	EFB force trip	A fault trip command has been received through the embedded fieldbus interface.	Check the fault information provided by the PLC.

Maintenance



WARNING! Read [Safety instructions](#) on page 2 before performing any maintenance on the equipment. Ignoring the safety instructions can cause injury or death.

Maintenance schedule

Recommended maintenance intervals and component replacements are based on specified operational and environmental conditions. ABB recommends annual drive inspections to ensure the highest reliability and optimum performance.

Note: Long term operation near the maximum specified ratings or environmental conditions may require shorter maintenance intervals for certain components. Consult your local ABB Service for maintenance recommendations at: www.abb.com/searchchannels

Description of symbols

Action	Description
I	Inspection (visual inspection and maintenance action if needed)
P	Performance of on/off-site work (commissioning, tests, measurements or other work)
R	Replacement

Recommended annual actions by the user

Action	Description
P	Quality of supply voltage
I	Spare parts
P	Capacitor reforming for spare drives and spare capacitors (page 88)
I	Tightness of terminals
I	Dustiness, corrosion or temperature
P	Heat sink cleaning (page 82)

Recommended maintenance actions by the user

Component Replacement	Years from start-up							Instruction
	3	6	9	12	15	18	21	
Cooling								
Fans, IP21 (UL (NEMA) Type 1) frames R1 to R9								
Main cooling fans R1...R5		R		R				R1...R4: page 83, R5...R8: page 83, R9: page 84
Main cooling fans R6...R9			R			R		R5...R9: page 84
Auxiliary cooling fan for circuit boards			R			R		R5...R9: page 84
Fans, IP55 (UL (NEMA) Type 12) frames R1 to R9								
Main cooling fans R1...R5		R		R		R		R1...R4: page 83, R5...R8: page 83, R9: page 84
Main cooling fans R6...R9			R			R		R5...R9: page 84
Auxiliary cooling fan for circuit boards R1...R2		R		R		R		R1...R2: page 85, R3: page 86, R4: page 87, R5...R9: page 84
Auxiliary cooling fan for circuit boards R3...R9			R			R		R5...R9: page 84
Second auxiliary cooling fan			R			R		R8 and R9: page 87
Aging								
Control panel battery			R			R		page 88

Heatsink

The heatsink fins accumulate dust from the cooling air. Since a dusty heatsink is less efficient at cooling the drive, overtemperature faults become more likely. In a “normal” environment (not dusty, not clean) check the heatsink annually, in a dusty environment check more often.

Clean the heatsink as follows (when necessary):

1. Remove power from drive. Wait 5 minutes and measure to confirm.
2. Remove the cooling fan(s) (see section [Main cooling fan replacement](#) below).
3. Blow clean, dry, oil-free condensed air (not humid) from bottom to top and simultaneously use a vacuum cleaner at the air outlet to trap the dust.

Note: If there is a risk of the dust entering adjoining equipment, perform the cleaning in another room.

4. Replace the cooling fan(s).
5. Restore power.

Main cooling fan replacement

Main cooling fans are speed-controlled, and the speed of the fan matches the cooling needs. When the drive is stopped, the main fan is kept running at a low speed to cool the control board. Replacement fans are available from ABB. Do not use other than ABB specified spare parts.

Frame Size R1...R3

To replace the fan:



WARNING! Obey the [Safety instructions](#) on page 2. Ignoring the instructions can cause physical injury or death, or damage to the equipment.

1. Stop the drive and disconnect it from the power line. Wait for 5 minutes and then make sure by measuring that there is no voltage. See section [Precautions before electrical work](#) on page 3 before you start the work.
2. Pry the fan assembly off the drive frame with a screwdriver (2a) and pull out of the fan assembly (2b) until you can unplug the fan power supply wires from the fan assembly (2c).
3. Install the fan assembly in reverse order.

R1...R2: Put the connector and extra length of wires in the groove so that the wires do not get caught in the revolving fan.

R3: Put the extra length of wires under the fan assembly so that the wires do not get caught in the revolving fan.

4. Restore power.

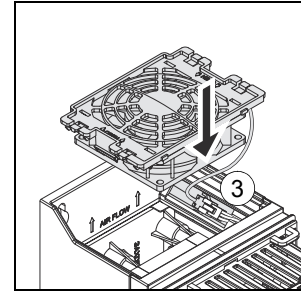
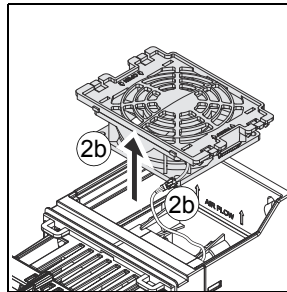
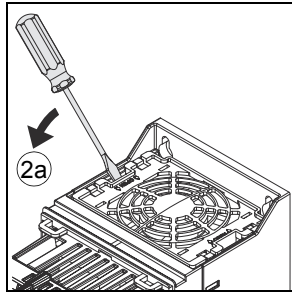
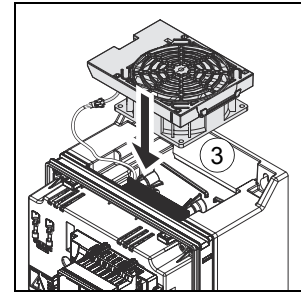
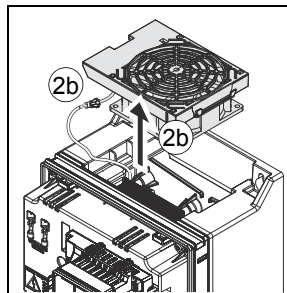
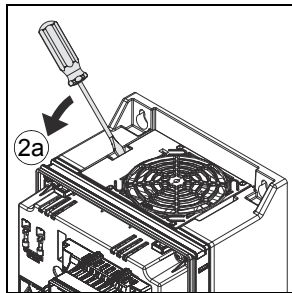
R1...R2**R3****Frame Size R4**

To replace the fan:

1. Remove power from drive.
2. Pry the fan assembly off the drive frame with a screwdriver and pull it out.
3. Disconnect the fan cable.
4. Install the fan in reverse order.
5. Restore power.

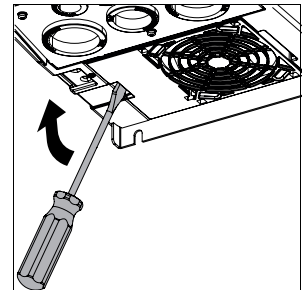
**Frame Sizes R5...R8**

To replace the fan:

1. Remove power from drive.
2. Remove the 2 screws attaching the fan mounting plate at the bottom of the drive.
3. Pull the mounting plate down from the side edge.
4. Disconnect the fan cable.
5. Lift the mounting plate off.
6. Remove the fan from the mounting plate.
7. Install the fan in reverse order.
8. Restore power.

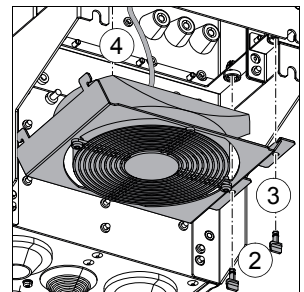

Frame Size R9

To replace the fans:

1. Remove power from drive.
2. Remove the 2 screws attaching the fan mounting plate.
3. Turn the mounting plate downwards.
4. Disconnect the fan cables
5. Remove the mounting plate.
6. Remove the fans by removing the 2 mounting screws.
7. Install the fan in reverse order.
8. Restore power.

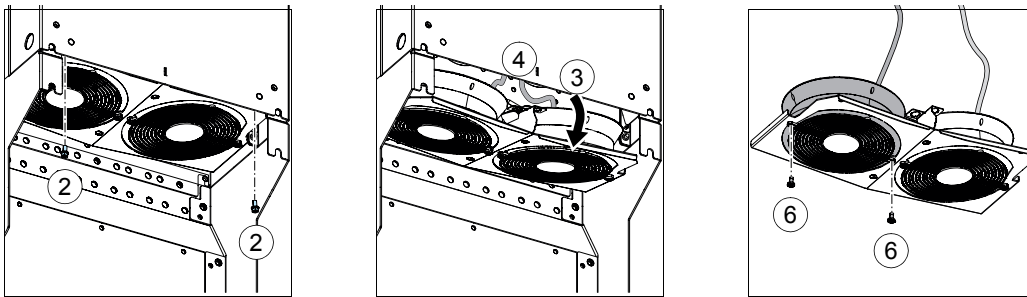
**Auxiliary cooling fan replacement**

Auxiliary cooling fans are not speed-controlled and run all the time that the control board is powered. Replacement fans are available from ABB. Do not use other than ABB specified spare parts.

IP21/UL (NEMA) Type 1 and IP55/UL (NEMA) Type 12 Frame Sizes R5...R9

To replace the fan:

1. Remove power from drive.
2. Remove the front cover.
3. Disconnect the fan cable.
4. Release the retaining clips.
5. Lift the fan off.
6. Install the fan in reverse order.

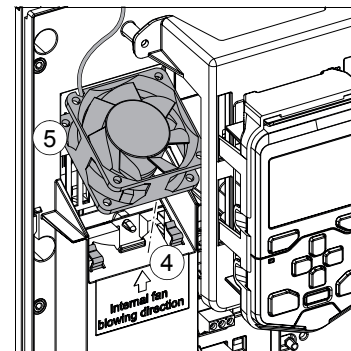

Note: Make sure that the arrow on the fan points up.

7. Restore power.

IP55/UL (NEMA) Type 12 Frame Sizes R1...R2

To replace the fan:



WARNING! Obey the [Safety instructions](#) on page 2. Ignoring the instructions can cause physical injury or death, or damage to the equipment.

1. Stop the drive and disconnect it from the power line. Wait for 5 minutes and then make sure by measuring that there is no voltage. See section [Precautions before electrical work](#) on page 3 before you start the work.
2. Remove the control panel: Press the retaining clip of the IP55 panel cover (2a) and open the cover (2b). Press the retaining clip of the control panel at the top (2c) and pull it forward from the top edge (2d).
3. Remove the front cover: Loosen the retaining screws with a screwdriver (3a) and lift the cover from the bottom outwards (3b) and then up (3c).
4. Unplug the fan power supply wires from the drive.
5. Remove the fingerguard: Insert a screwdriver into the hole of the fingerguard (5a), bend the front edge of the fingerguard a little away from the drive frame with the screwdriver (5b) and pull the fingerguard out of the groove (5c).
6. Pull off the fan.
7. Install the new fan assembly in reverse order. Route the wires round the pins.

Note: Make sure that the arrow on the fan points to the same direction as the arrow on the drive frame.

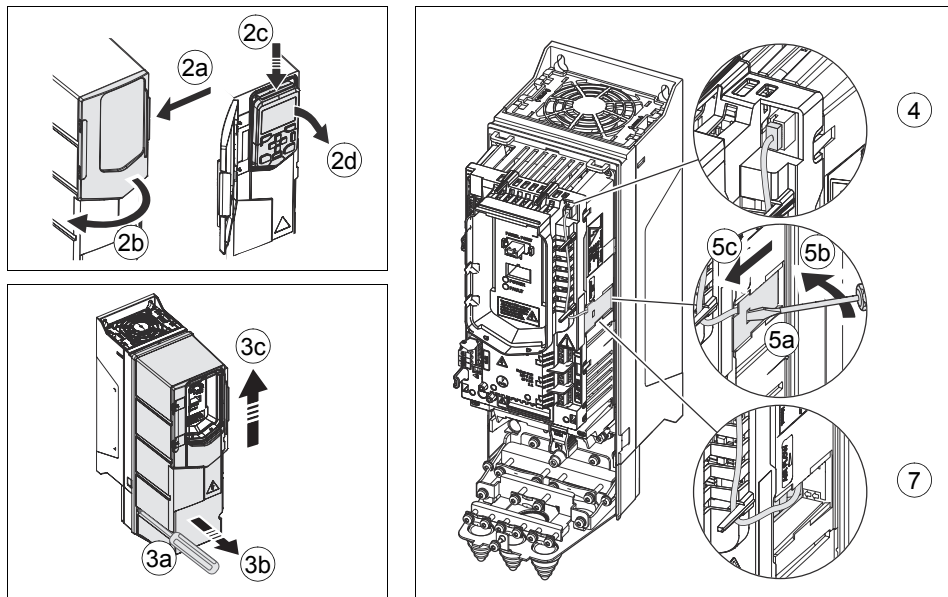

8. Restore power.

IP55/UL (NEMA) Type 12 Frame Size R3

To replace the fan:



WARNING! Obey the [Safety instructions](#) on page 2. Ignoring the instructions can cause physical injury or death, or damage to the equipment.

1. Stop the drive and disconnect it from the power line. Wait for 5 minutes and then make sure by measuring that there is no voltage. See section [Precautions before electrical work](#) on page 3 before you start the work.
2. Remove the control panel: Press the retaining clip of the IP55 panel cover (2a) and open the cover (2b). Press the retaining clip of the control panel at the top (2c) and pull it forward from the top edge (2d).
3. Remove the front cover: Loosen the retaining screws with a screwdriver (3a) and lift the cover from the bottom outwards (3b) and then up (3c).
4. Unplug the fan power supply wires from the drive.
5. Detach the fan cable from the holders.
6. Pull off the plastic housing.
7. Pull off the fan.
8. Install the new fan and housing in reverse order.

Note: Make sure that the arrow on the fan points to the same direction as the arrow on the plastic housing (down).

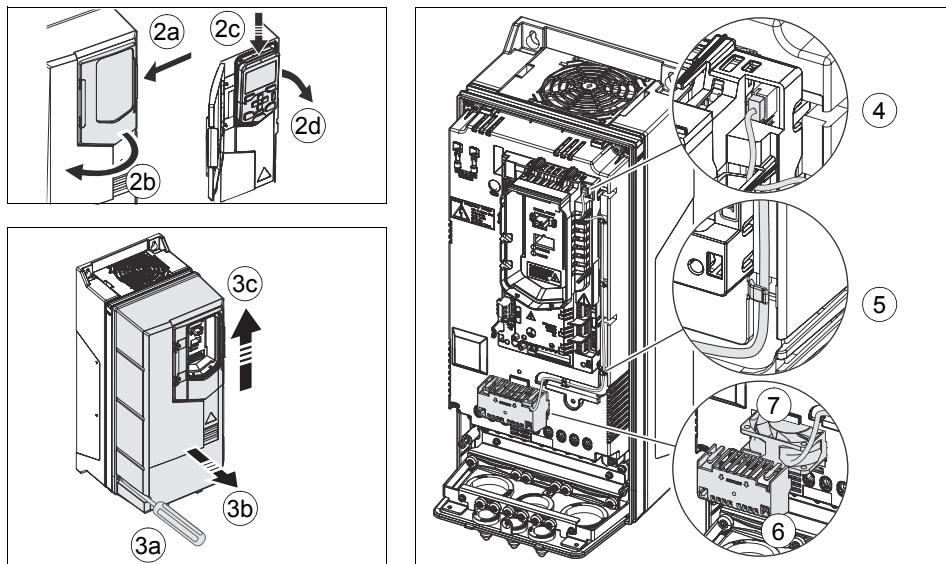

9. Restore power.

IP55/UL (NEMA) Type 12 Frame Size R4

To replace the fan:

1. Remove power from drive.
2. Remove the control panel: Press the retaining clip at the top and pull it forward.
3. Remove the front cover: Loosen the retaining screws at the bottom left and pull the cover outwards from the bottom and then up.
4. Unplug the fan cable from the drive.
5. Detach the fan cable from the clips.
6. Pull off the fan.
7. Install the fan in reverse order.

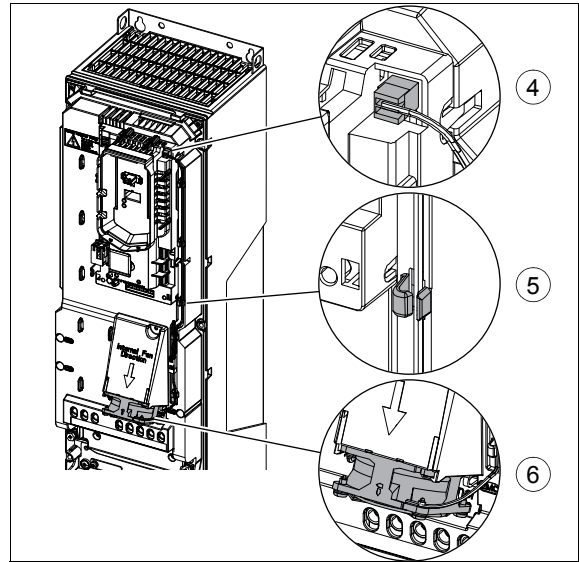

Note: Make sure that the arrow on the fan points up.

8. Restore power.

Second auxiliary cooling fan replacement*IP55/UL (NEMA) Type 12 Frame Sizes R8...R9*

To replace the fan:

1. Remove power from drive.
2. Remove the front cover: Loosen the 14 retaining screws and pull the cover outwards from the bottom and then up.
3. Remove the lower cover panel from the cover.
4. Unplug the fan cable from the connector on the other side.
5. Remove the retaining screws (5a) and pull off the fan (5b).
6. Install the fan in reverse order.

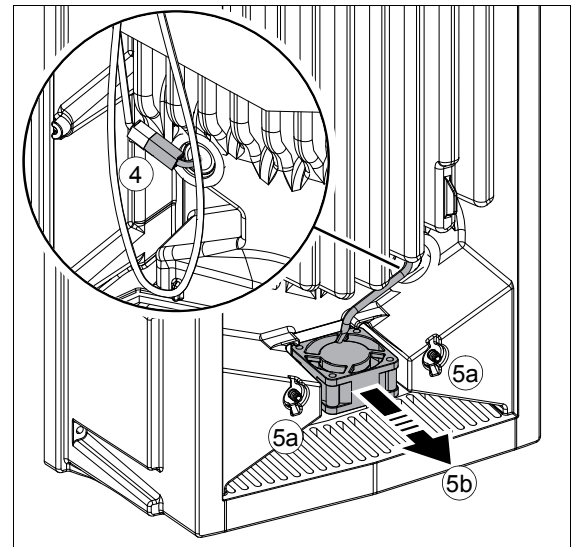

Note: Make sure that the arrow on the fan points up.

7. Restore power.

Capacitors

The drive intermediate DC circuit employs several electrolytic capacitors. Their lifespan depends on the operating time of the drive, loading and ambient temperature. Capacitor life can be prolonged by lowering the ambient temperature.

Capacitor failure is usually followed by damage to the drive and an input cable fuse failure, or a fault trip. Contact the manufacturer if capacitor failure is suspected. Replacements are available from the manufacturer. Do not use other than specified spare parts.

Reforming the capacitors

The capacitors must be reformed if the drive has not been powered (either in storage or unused) for a year or more. See label on page 7 for how to find out the manufacturing date from the serial number.

For information on reforming the capacitors, see *Converter module capacitor reforming instructions* (3BFE64059629 [English]), available on the Internet (go to <http://www.abb.com> and enter the document code in the Search field).

Control panel

Cleaning

Use a soft damp cloth to clean the control panel. Avoid harsh cleaners which could scratch the display window.

Battery

A battery is used in all control panels to keep the clock operating in memory during power interruptions.

The expected life for the battery is greater than ten years. To remove the battery, use a coin to rotate the battery holder on the back of the control panel. Replace the battery with type CR2032.

Note: The battery is NOT required for any control panel or drive function, except the real-time clock.

ACH580 E-Clipse Bypass

Installation – Drive

Follow the [Installation](#) instructions for the drive on page 8. **Failure to observe the warnings and instructions may cause a malfunction or personal hazard.**



WARNING! Before you begin read [Safety instructions](#) on page 2.



WARNING! Bypass configurations (ACH580-VxR & ACH580-BxR) do not support Safe Torque Off (STO) functionality.

Enclosure Designation	Horsepower Range by Voltage Rating		
	208V	460V	575V ²
V1	1 to 3 HP	1 to 7.5 HP	N/A
V2	5 to 7.5 HP	10 to 15 HP	2 to 15 HP
V3	10 HP	20 to 30 HP	20 to 30 HP
V4	15 to 25 HP	40 to 60 HP	N/A
B1	1 to 7.5 HP	1 to 15 HP	2 to 15 HP
B2	10 to 25 HP	20 to 60 HP	20 to 30 HP
B3	30 to 100 HP ¹	75 to 200 HP	40 to 150 HP

1) 100 HP @ 230V.

2) VCR and BCR are rated 600Y/347V unless otherwise specified. For use on a solidly grounded Wye source only.

Installation – Bypass



WARNING! When the ACH580 with E-Clipse Bypass is connected to the line power, the Motor Terminals T1, T2, and T3 may be live even if the motor is not running. Do not make any connections when the ACH580 with E-Clipse Bypass is connected to the line. Disconnect and lock out power to the drive before servicing the drive. Failure to disconnect power may cause serious injury or death.

1. Install wiring – Bypass



WARNING!

- Metal shavings or debris in the enclosure can damage electrical equipment and create a hazardous condition. Where parts, such as conduit plates require cutting or drilling, first remove the part. If that is not practical, cover nearby electrical components to protect them from all shavings or debris.
 - Do not connect or disconnect input or output power wiring, or control wires, when power is applied.
 - Never connect line voltage to drive output Terminals T1, T2, and T3.
 - Do not make any voltage tolerance tests (Hi Pot or Megger) on any part of the unit. Disconnect motor wires before taking any measurements in the motor or motor wires.
 - Make sure that power factor correction capacitors are not connected between the drive and the motor.
-

Connection diagrams – Vertical E-Clipse Bypass

ACH580 Vertical E-Clipse Bypass units are configured for wiring access from the bottom only. The following figures show the layout and wiring connection points. For drive control wiring see pages 29-41. Maintain appropriate separation of control and power wires.

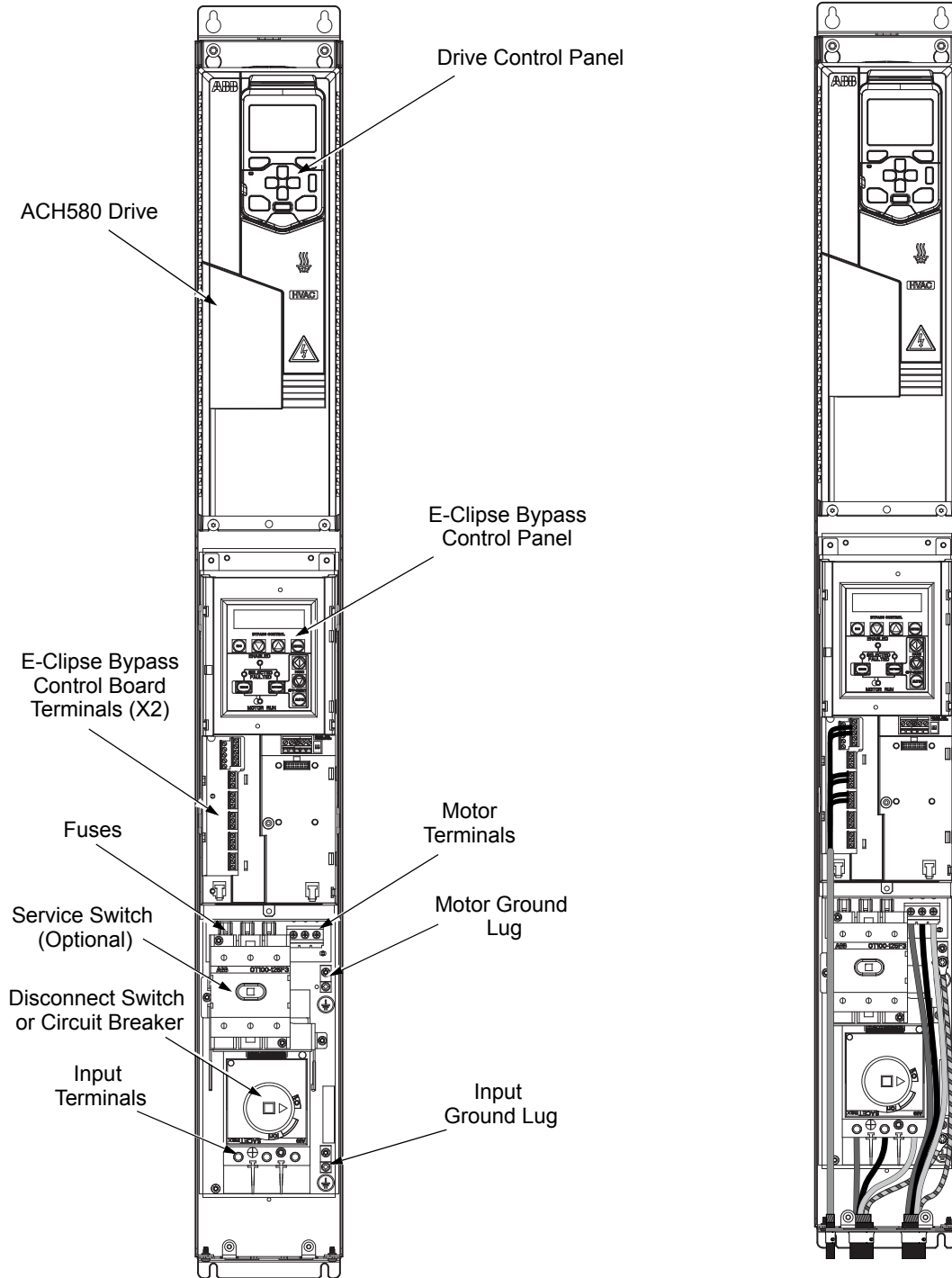

V1/V2
(Vx1-1, Vx1-2)

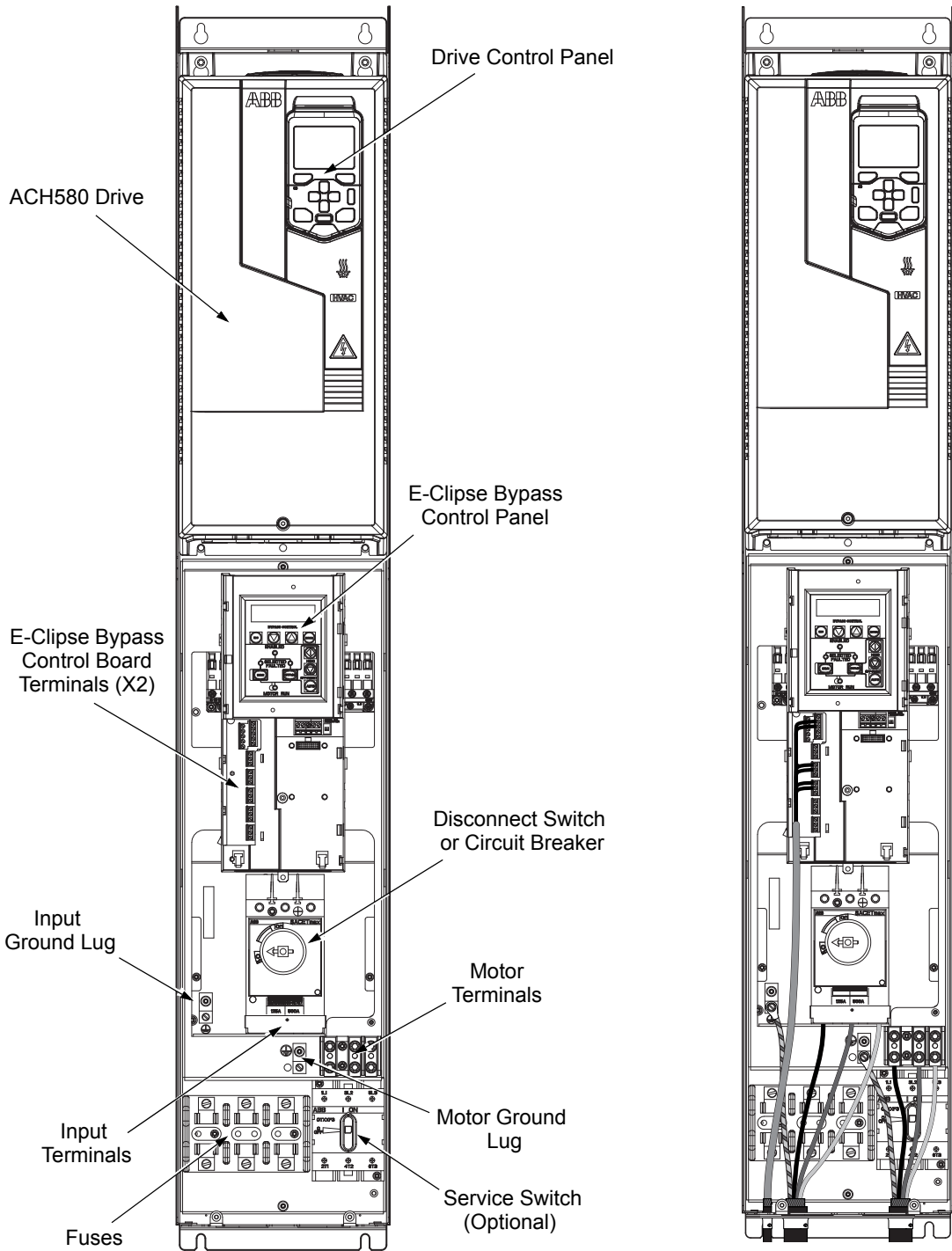

V3/V4
(Vx1-3, Vx1-4)

Connection diagrams – Box E-Clipse Bypass

ACH580 Box E-Clipse Bypass units are configured for wiring access from the top (for UL (NEMA) Type 1 and 12) and from the bottom (for UL (NEMA) Type 3R). The following figures show the layout and wiring connection points. For drive control wiring see pages 29-41. Maintain appropriate separation of control and power wires.

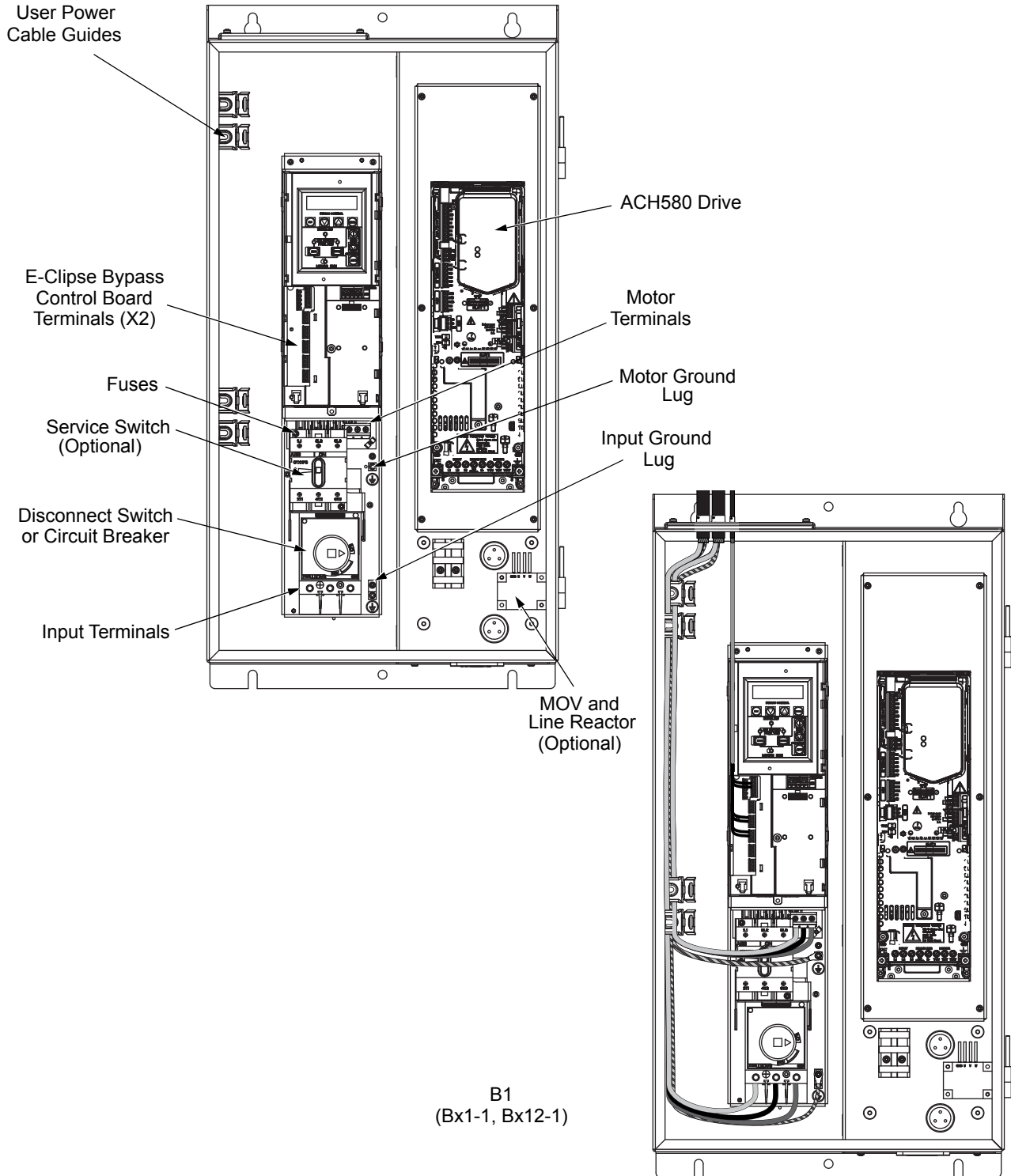

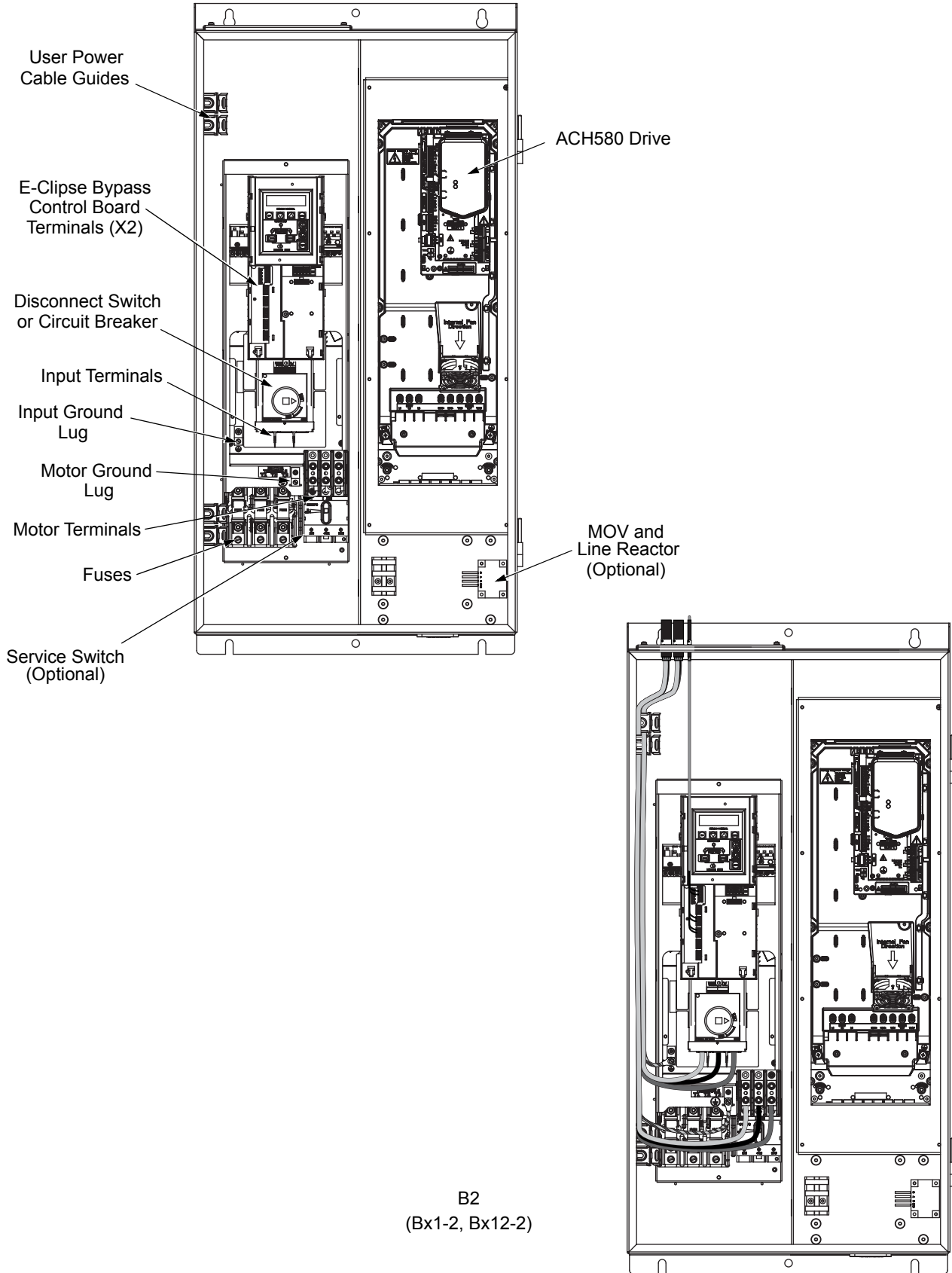

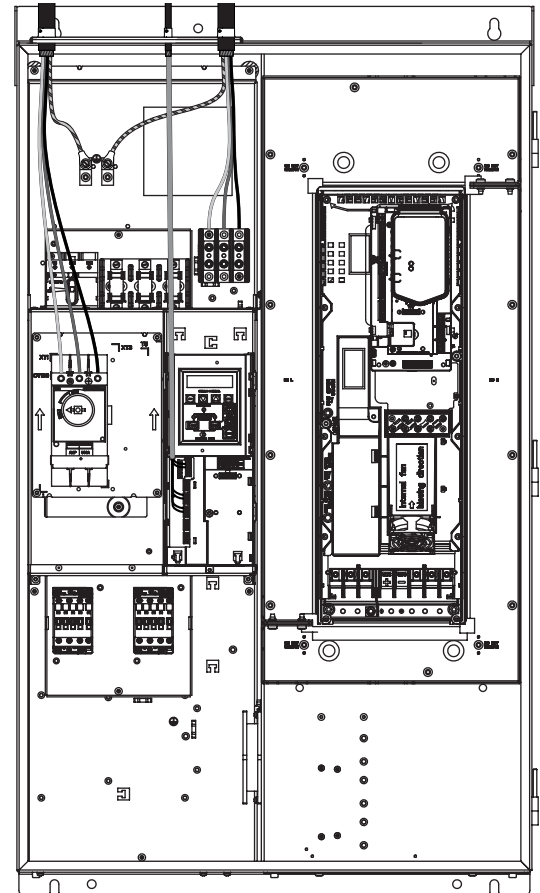
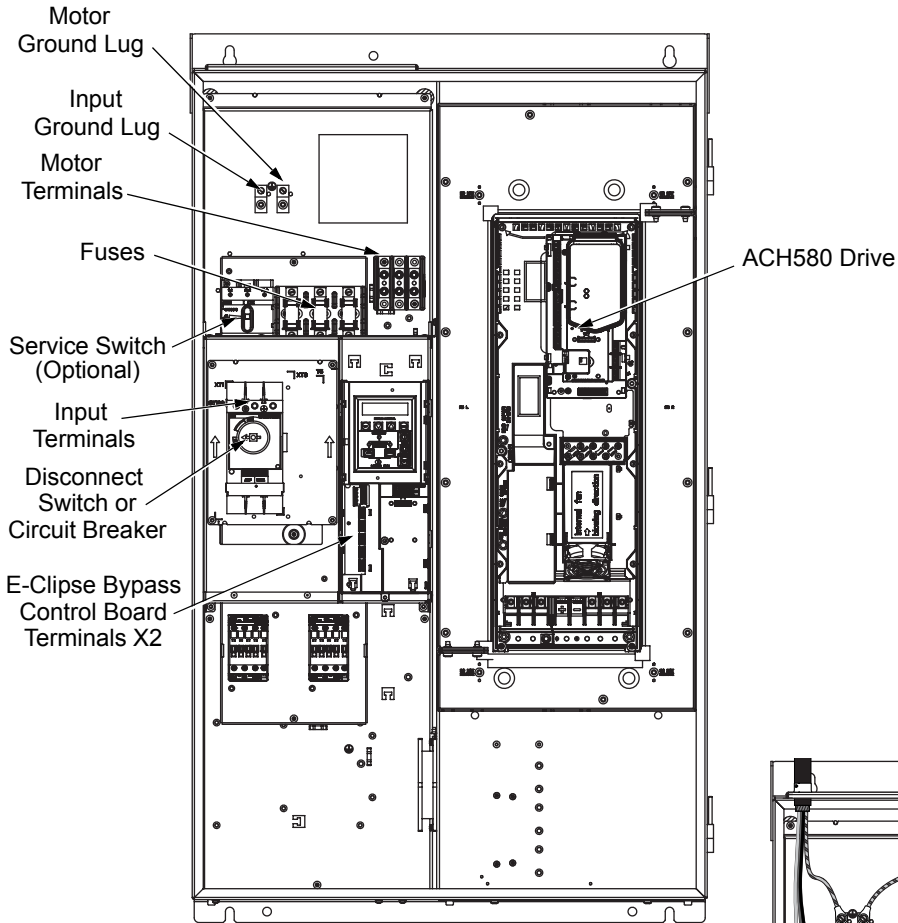

B3
600V, 41A - 77A
(Bx1-3, Bx12-3*)

*Hood and filter kit not shown

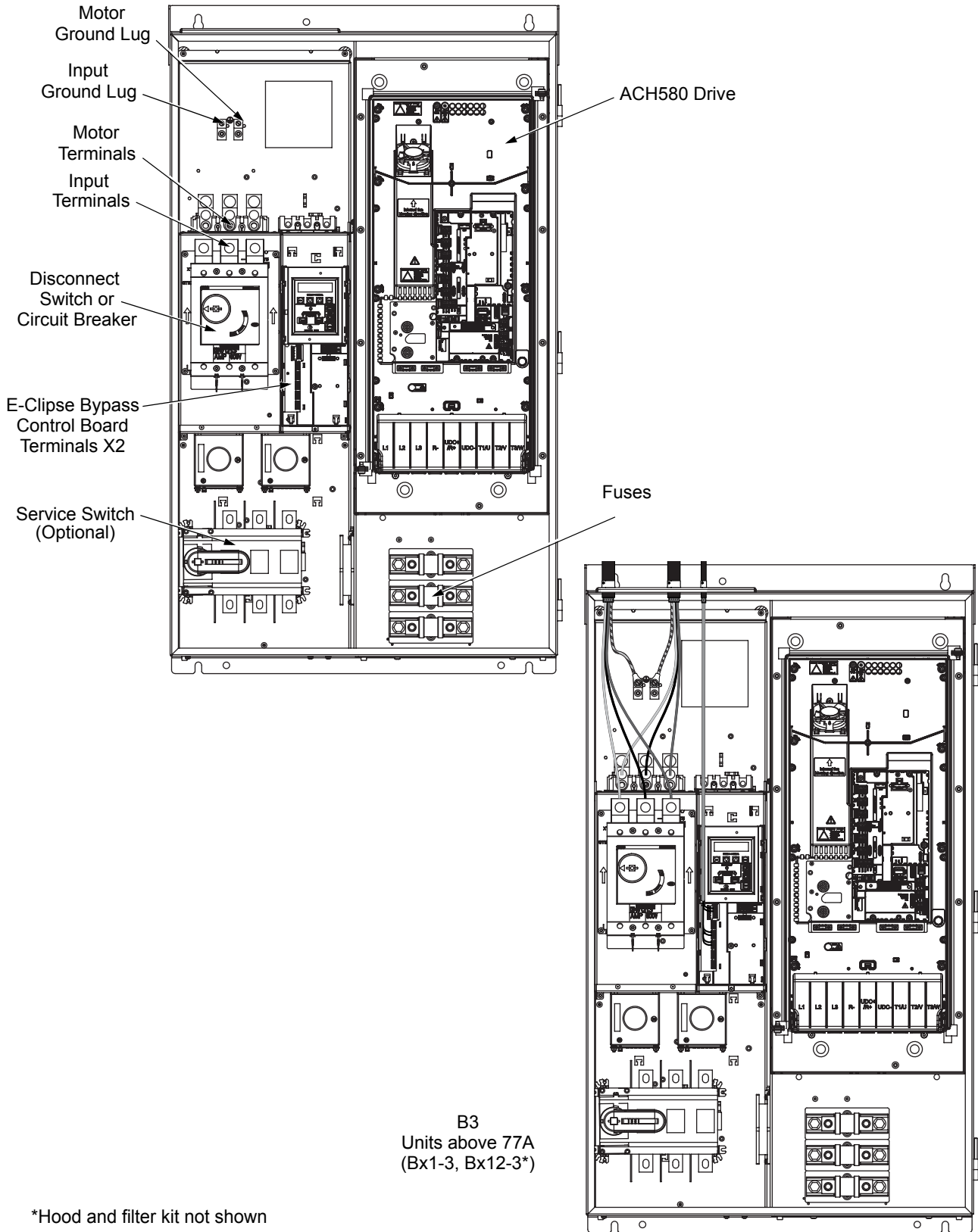

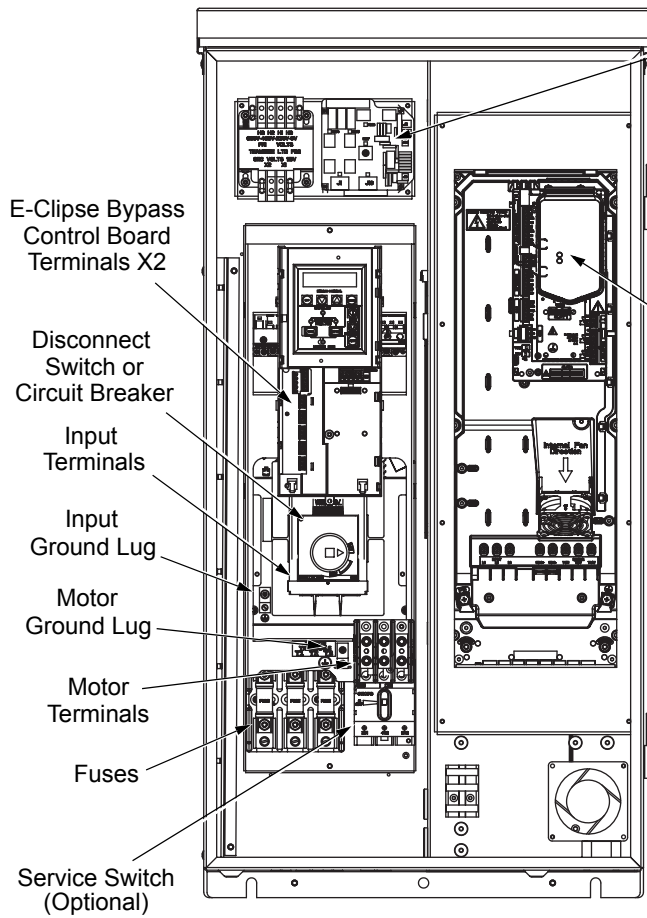

RHTR Temperature HI/LO Jumper (X1)	Heater ON Temperature	Heater OFF Temperature
Default Setting (X1 jumper in LO position)	14.4 °C 58 °F	21.4 °C 70.5 °F
Alternate Setting (X1 jumper in HI position)	17.8 °C 64 °F	24.4 °C 76.5 °F

The alternate (HI) setting further reduces the likelihood of condensate in high humidity environments.

ACH580 Drive

B2
(Bx3R-2)

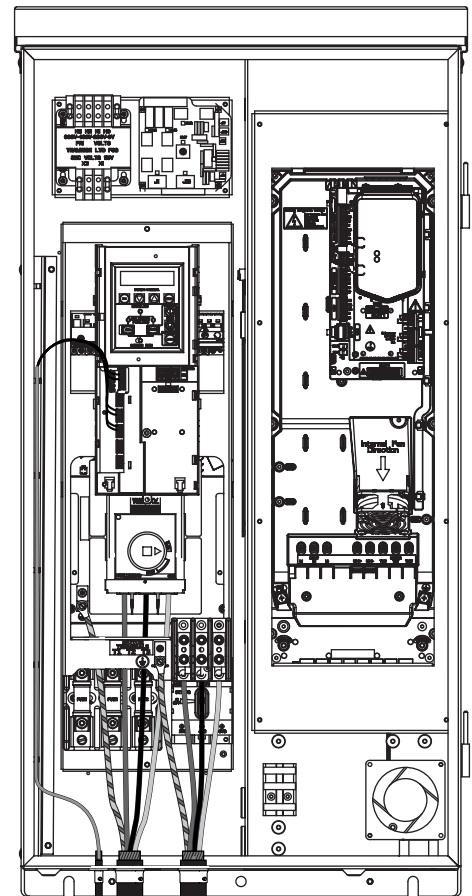

Power connections – Box E-Clipse Bypass configurations

Line input connections

Connect the input power to the terminals at the bottom of the disconnect switch or circuit breaker. Also see [Connection diagrams – Vertical E-Clipse Bypass](#) on page 91. Connect the equipment grounding conductor to the ground lug near the input power connection point.

Motor connections

Connect the motor cables to the terminals at the bottom of the bypass section. Also see [Connection diagrams – Vertical E-Clipse Bypass](#) on page 91. Connect the motor grounding conductor to the ground lug near the motor cable terminal block connection point.

Power connections – Standard E-Clipse Bypass configurations (wall mounted)

Line input connections

Connect input power to the terminals of the disconnect switch or circuit breaker. Connect the equipment grounding conductor to the ground lug at the top of the enclosure. The figure below shows the connection points for Standard E-Clipse Bypass configurations. Also see [Connection diagrams – Box E-Clipse Bypass](#) on page 93.

Motor connections

Connect the motor cables to the output terminal block as shown in [Basic connections](#) on page 99. Also see [Connection diagrams – Box E-Clipse Bypass](#) on page 93. The motor grounding conductor can be connected to the ground lug near the terminal block.

Note: Route cables through the cable guides on the left side of the enclosure. Use separate conduits for input power and motor cables. Follow the guides to separate the cables from each other.



WARNING! Check the motor and motor wiring insulation before connecting the ACH580 to line power. Follow the procedure on page 16. Before proceeding with the insulation resistance measurements, check that the ACH580 is disconnected from incoming line power. Failure to disconnect line power could result in death or serious injury.

Install the control wiring

Connect control wiring to terminal block X1 on the ACH580 control board and to terminal block X2 on the E-Clipse Bypass control board. For more information on these connections, refer to the following:

- X1 terminal block location and terminal data are defined in the [Installation](#) instructions for the drive on page 40.
- X2 terminal block location is illustrated in the figures starting with [Connection diagrams – Vertical E-Clipse Bypass](#) on page 91.
- X2 terminal data are provided in [Basic control connections for E-Clipse HVAC Default](#) on page 108.
- Basic connections are described in the following paragraphs. Alternate configurations using the E-Clipse Bypass macro are described in the *ACH580 HVAC control program firmware manual*.
- On Terminal Block X1 inside the ACH580, analog inputs and outputs and additional digital input and relay output connections (AI1, AI2, AO1, AO2, DI1...DI6 and RO1...RO6) are available for use.

Note: The E-Clipse Bypass control circuitry uses serial communications connections (X1:29...X1:31) inside the ACH580. These connections are not available for any other purpose and must not be reconfigured.

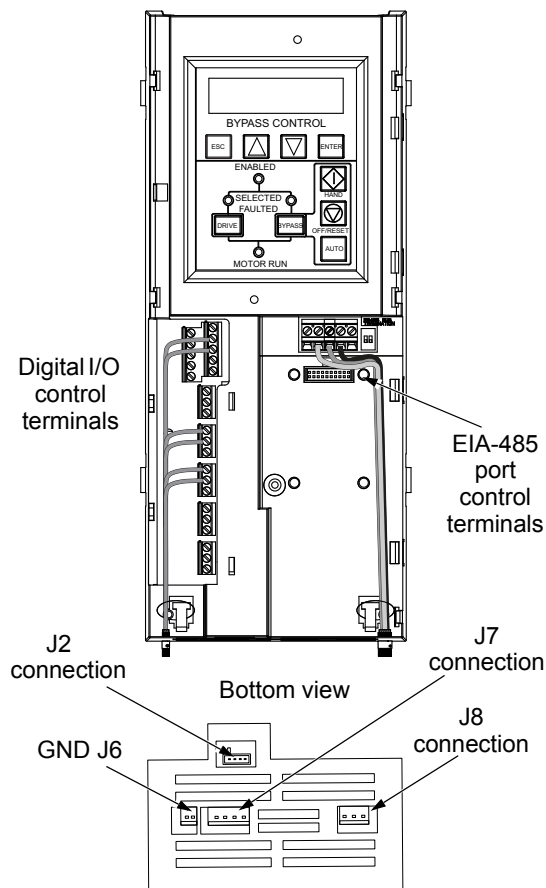

Basic connections

The figure on page 108 shows the basic control connections for use with the E-Clipse Bypass HVAC Default macro. These connections are described in the following paragraphs.

In typical installations, only analog input wires connect to the ACH580 terminal block, with other control connections made on the E-Clipse Bypass control board.

Use wire ties to permanently affix control/communications wiring to the hooked wire race tie points provided, maintaining a minimum 6 mm (1/4 in.) spacing from power wiring.

Drive's power connection terminals

The following tables list the maximum power and motor cable terminal sizes for connections to an input circuit breaker or disconnect switch, a motor terminal block and ground lugs. The tables also list torque that should be applied when tightening the terminals.

Vertical enclosure terminals maximum wire size and terminal torque values

Type Code ¹	Nominal Output Ratings		Frame Size	Maximum Wire Size and Terminal Torque			
	Drive Current	Package Power		Circuit Breaker	Disconnect Switch	Motor Termination	Ground Lugs
	A	HP					
208/230 Volts							
ACH580-VxR-04A6-2	4.6	1	R1	#10 62 in-lbs	#10 55 in-lbs	#6 11-13 in-lbs	#4 35 in-lbs
ACH580-VxR-06A6-2	6.6	1.5	R1				
ACH580-VxR-07A5-2	7.5	2	R1				
ACH580-VxR-10A6-2	10.6	3	R1	#8 62 in-lbs	#6 55 in-lbs	#1 35 in-lbs	#2 50 in-lbs
ACH580-VxR-017A-2	16.7	5	R1				
ACH580-VxR-024A-2	24.2	7.5	R2				
ACH580-VxR-031A-2	30.8	10	R2	#2 62 in-lbs	#4 55 in-lbs	#2/0 110 in-lbs	#2 50 in-lbs
ACH580-VxR-046A-2	46.2	15	R3				
ACH580-VxR-059A-2	59.4	20	R3				
ACH580-VxR-075A-2	74.8	25	R4	#2 62 in-lbs	#1 55 in-lbs	#2/0 110 in-lbs	#2 50 in-lbs

1) "VxR" represents both VCR and VDR.

Type Code ¹	Nominal Output Ratings		Frame Size	Maximum Wire Size and Terminal Torque					
	Drive Current	Package Power		Circuit Breaker	Disconnect Switch	Motor Termination	Ground Lugs		
	A	HP							
460 Volts									
ACH580-VxR-02A1-4	2.1	1	R1	#12 62 in-lbs	#10 55 in-lbs	#6 11-13 in-lbs	#4 35 in-lbs		
ACH580-VxR-03A0-4	3.0	1.5	R1						
ACH580-VxR-03A5-4	3.5	2	R1						
ACH580-VxR-04A8-4	4.8	3	R1						
ACH580-VxR-07A6-4	7.6	5	R1						
ACH580-VxR-012A-4	12	7.5	R1						
ACH580-VxR-014A-4	14	10	R2	#10 62 in-lbs	#8 55 in-lbs	#1 35 in-lbs	#2 50 in-lbs		
ACH580-VxR-023A-4	23	15	R2						
ACH580-VxR-027A-4	27	20	R3	#8 62 in-lbs	#4 55 in-lbs			#2/0 110 in-lbs	#2 50 in-lbs
ACH580-VxR-034A-4	34	25	R3						
ACH580-VxR-044A-4	44	30	R3						
ACH580-VxR-052A-4	52	40	R4	#2 62 in-lbs	#2 55 in-lbs			#2/0 110 in-lbs	#2 50 in-lbs
ACH580-VxR-065A-4	65	50	R4						
ACH580-VxR-077A-4	77	60	R4						

1) "VxR" represents both VCR and VDR.

Type Code ¹	Nominal Output Ratings		Frame Size	Maximum Wire Size and Terminal Torque			
	Drive Current	Package Power		Circuit Breaker	Disconnect Switch	Motor Termination	Ground Lugs
	A	HP					
575 Volts²							
ACH580-VxR-02A7-6	2.7	2	R2	#10 62 in-lbs	#10 55 in-lbs	#6 11-13 in-lbs	#4 35 in-lbs
ACH580-VxR-03A9-6	3.9	3	R2				
ACH580-VxR-06A1-6	6.1	5	R2				
ACH580-VxR-09A0-6	9	7.5	R2				
ACH580-VxR-011A-6	11	10	R2		#6 55 in-lbs	#1 35 in-lbs	#2 50 in-lbs
ACH580-VxR-017A-6	17	15	R2				
ACH580-VxR-022A-6	22	20	R3				
ACH580-VxR-027A-6	27	25	R3				
ACH580-VxR-032A-6	32	30	R3	#4 55 in-lbs			

- 1) "VxR" represents both VCR and VDR.
- 2) VCR is rated 600Y/347V. For use on a solidly grounded Wye source only.

Box enclosure terminals maximum wire size and terminal torque values

Type Code ¹	Nominal Output Ratings		Base Drive Frame Size	Maximum Wire Size and Terminal Torque							
	Drive Current	Package Power		Circuit Breaker UL (NEMA) Type 1 and 12	Circuit Breaker UL (NEMA) Type 3R	Disconnect Switch UL (NEMA) Type 1 and 12	Disconnect Switch UL (NEMA) Type 3R	Motor Terminals UL (NEMA) Type 1 and 2	Motor Terminals UL (NEMA) Type 3R	Ground Lugs UL (NEMA) Type 1 and 2	Ground Lugs UL (NEMA) Type 3R
	A	HP									
208/230 Volts											
ACH580-BxR-04A6-2	4.6	1	R1	#12 62 in-lbs	#12 62 in-lbs	#10 55 in-lbs	#10 55 in-lbs	#6 11-13 in-lbs	#6 11-13 in-lbs	#4 35 in-lbs	#4 35 in-lbs
ACH580-BxR-06A6-2	6.6	1.5	R1								
ACH580-BxR-07A5-2	7.5	2	R1								
ACH580-BxR-10A6-2	10.6	3	R1								
ACH580-BxR-017A-2	16.7	5	R1	#8 62 in-lbs	#8 62 in-lbs	#6 55 in-lbs	#6 55 in-lbs	#1 35 in-lbs	#1 35 in-lbs	#2 50 in-lbs	#2 50 in-lbs
ACH580-BxR-024A-2	24.2	7.5	R2								
ACH580-BxR-031A-2	30.8	10	R2								
ACH580-BxR-046A-2	46.2	15	R3	#2 62 in-lbs	#2 62 in-lbs	#2 55 in-lbs	#2 55 in-lbs	#2/0 110 in-lbs	#2/0 110 in-lbs	#2 50 in-lbs	#2 50 in-lbs
ACH580-BxR-059A-2	59.4	20	R3			#1 55 in-lbs	#1 55 in-lbs				
ACH580-BxR-075A-2	74.8	25	R4			#1/0 75 in-lbs	#1/0 75 in-lbs				
ACH580-BxR-088A-2	88	30	R5	#1/0 124 in-lbs	Consult factory	#2/0 275 in-lbs	Consult factory	#2/0 71 in-lbs	Consult factory	#1/0 50 in-lbs	Consult factory
ACH580-BxR-114A-2	114	40	R6			#4/0 275 in-lbs		300 MCM 301 in-lbs			
ACH580-BxR-143A-2	143	50	R6			#3/0 124 in-lbs		300 MCM 275 in-lbs			
ACH580-BxR-169A-2	169	60	R7			373 MCM 274 in-lbs		2 X 500 MCM 274 in-lbs			
ACH580-BxR-211A-2	211	75	R7			2 X 500 MCM 372 in-lbs					
ACH580-BxR-248A-2	248	100 ²	R8								

- 1) "BxR" represents both BCR and BDR.
- 2) 100 HP @ 230V.

Type Code ¹	Nominal Output Ratings		Base Drive Frame Size	Maximum Wire Size and Terminal Torque							
	Drive Current	Package Power		Circuit Breaker UL (NEMA) Type 1 and 12	Circuit Breaker UL (NEMA) Type 3R	Disconnect Switch UL (NEMA) Type 1 and 12	Disconnect Switch UL (NEMA) Type 3R	Motor Terminals UL (NEMA) Type 1 and 2	Motor Terminals UL (NEMA) Type 3R	Ground Lugs UL (NEMA) Type 1 and 2	Ground Lugs UL (NEMA) Type 3R
	A	HP									
460 Volts											
ACH580-BxR-02A1-4	2.1	1	R1	#12 62 in-lbs	#12 62 in-lbs	#10 55 in-lbs	#10 55 in-lbs	#6 11-13 in-lbs	#6 11-13 in-lbs	#4 35 in-lbs	#4 35 in-lbs
ACH580-BxR-03A0-4	3.0	1.5	R1								
ACH580-BxR-03A5-4	3.5	2	R1								
ACH580-BxR-04A8-4	4.8	3	R1								
ACH580-BxR-07A6-4	7.6	5	R1								
ACH580-BxR-012A-4	12	7.5	R1	#10 62 in-lbs	#10 62 in-lbs	#8 55 in-lbs	#8 55 in-lbs	#1 35 in-lbs	#1 35 in-lbs	#2 50 in-lbs	#2 50 in-lbs
ACH580-BxR-014A-4	14	10	R2			#6 55 in-lbs	#6 55 in-lbs				
ACH580-BxR-023A-4	23	15	R2	#8 62 in-lbs	#8 62 in-lbs	#4 55 in-lbs	#4 55 in-lbs	#1 35 in-lbs	#1 35 in-lbs	#2/0 110 in-lbs	#2/0 110 in-lbs
ACH580-BxR-027A-4	27	20	R3			#3 55 in-lbs	#3 55 in-lbs				
ACH580-BxR-034A-4	34	25	R3			#2 62 in-lbs	#2 62 in-lbs				
ACH580-BxR-044A-4	44	30	R3	#1 55 in-lbs	#1 55 in-lbs						
ACH580-BxR-052A-4	52	40	R4	#1/0 75 in-lbs	#1/0 75 in-lbs						
ACH580-BxR-065A-4	65	50	R4	#1/0 124 in-lbs	#2/0 124 in-lbs	Consult factory	Consult factory	#2/0 71 in-lbs	Consult factory	#1/0 50 in-lbs	Consult factory
ACH580-BxR-077A-4	77	60	R4								
ACH580-BxR-096A-4	96	75	R5								
ACH580-BxR-124A-4	124	100	R6								
ACH580-BxR-156A-4	156	125	R7								
ACH580-BxR-180A-4	180	150	R7	350 MCM 274 in-lbs	350 MCM 274 in-lbs	Consult factory	Consult factory	2 X 500 MCM 372 in-lbs	Consult factory	Consult factory	
ACH580-BxR-240A-4	240	200	R8								

1) "BxR" represents both BCR and BDR.

Type Code ¹	Nominal Output Ratings		Base Drive Frame Size	Maximum Wire Size and Terminal Torque							
	Drive Current	Package Power		Circuit Breaker UL (NEMA) Type 1 and 12	Circuit Breaker UL (NEMA) Type 3R	Disconnect Switch UL (NEMA) Type 1 and 12	Disconnect Switch UL (NEMA) Type 3R	Motor Terminals UL (NEMA) Type 1 and 2	Motor Terminals UL (NEMA) Type 3R	Ground Lugs UL (NEMA) Type 1 and 2	Ground Lugs UL (NEMA) Type 3R
	A	HP									
575 Volts²											
ACH580-BxR-02A7-6	2.7	2	R2	#12 62 in-lbs	#12 62 in-lbs	#10 55 in-lbs	#10 55 in-lbs	#6 11-13 in lbs	#6 11-13 in lbs	#4 35 in-lbs	#4 35 in-lbs
ACH580-BxR-03A9-6	3.9	3	R2								
ACH580-BxR-06A1-6	6.1	5	R2								
ACH580-BxR-09A0-6	9	7.5	R2								
ACH580-BxR-011A-6	11	10	R2	#10 62 in-lbs	#10 62 in-lbs	#6 55 in-lbs	#6 55 in-lbs	#1 35 in-lbs	#1 35 in-lbs	#2 50 in-lbs	#4 35 in-lbs
ACH580-BxR-017A-6	17	15	R2								
ACH580-BxR-022A-6	22	20	R3	#6 62 in-lbs	#10 62 in-lbs	#4 55 in-lbs	#4 55 in-lbs	#1 35 in-lbs	#1 35 in-lbs	#2 50 in-lbs	#4 35 in-lbs
ACH580-BxR-027A-6	27	25	R3								
ACH580-BxR-032A-6	32	30	R3	#6 62 in-lbs	Consult factory	#3 55 in-lbs	Consult factory	#1 35 in-lbs	#1 35 in-lbs	#2 50 in-lbs	#4 35 in-lbs
ACH580-BxR-041A-6	41	40	R5								
ACH580-BxR-052A-6 ³	52	50	R5	#2 62 in-lbs	Consult factory	#2 55 in-lbs	Consult factory	#2/0 110 in-lbs	Consult factory	#2 50 in-lbs	#4 35 in-lbs
ACH580-BxR-062A-6	62	60	R5								
ACH580-BxR-077A-6	77	75	R5	#1 62 in-lbs	Consult factory	#1 275 in-lbs	Consult factory	#2/0 110 in-lbs	Consult factory	#2 50 in-lbs	#4 35 in-lbs
ACH580-BxR-099A-6	99	100	R7								
ACH580-BxR-125A-6	125	125	R7	#3/0 124 in-lbs	Consult factory	#1/0 275 in-lbs	Consult factory	#2/0 71 in-lbs	Consult factory	3 x #3/0	Consult factory
ACH580-BxR-144A-6	144	150	R8								
ACH580-BxR-144A-6	144	150	R8	250 MCM 124 in-lbs	Consult factory	250 MCM 275 in-lbs	Consult factory	300 MCM 301 in-lbs	Consult factory	250 in-lbs	Consult factory

- 1) "BxR" represents both BCR and BDR.
- 2) BCR is rated 600Y/347V unless otherwise specified. For use on a solidly grounded Wye source only.
- 3) BCR supports Delta network configuration.

Branch circuit protection

Input power is connected to the ACH580 with E-Clipse Bypass through a door interlocked disconnect switch or circuit breaker. Neither of these inputs are fused. The branch circuit that provides power to the ACH580 with E-Clipse Bypass with disconnect switch must include the specified external fuses to provide short circuit and ground fault protection for the motor in the bypass mode.

When connected to a 240V or 480V power source, the ACH580 with E-Clipse Bypass with the circuit breaker option is suitable for use on a circuit capable of delivering not more than 100,000 RMS symmetrical amperes. When connected to a 600V power source ABB E-Clipse units provided with a circuit breaker, VCR and BCR configurations, are suitable for use on a circuit capable of delivering not more than 10,000 RMS symmetrical amperes.

Fuses

Note: The UL listed drive fuses in the table are provided in the purchased product.

- Replacement fuses are required to be of the same class, current rating, and voltage rating. Fuses from other manufacturers can be used if they are 600V rated and meet the specifications given in the table.
- Fuses with higher current rating than specified must not be used.

208/230 Volt fuses for vertical enclosures

Type Code ¹	Nominal Output Ratings		Base Drive Frame Size	Internal Drive Fuse Rating		External Fuse for Disconnect Option	
	Drive Current	Package Power		Class	Max Current Rating	Class	Max Current Rating
	A	HP					
208/230 Volts							
ACH580-VxR-04A6-2	4.6	1	R1	Class CC	15A	Class J	15A
ACH580-VxR-06A6-2	6.6	1.5	R1	Class CC	15A	Class J	15A
ACH580-VxR-07A5-2	7.5	2	R1	Class CC	15A	Class J	20A
ACH580-VxR-10A6-2	10.6	3	R1	Class CC	15A	Class J	25A
ACH580-VxR-017A-2	16.7	5	R1	Class CC	30A	Class J	40A
ACH580-VxR-024A-2	24.2	7.5	R2	Class CC	30A	Class J	45A
ACH580-VxR-031A-2	30.8	10	R2	Class T	40A	Class J	60A
ACH580-VxR-046A-2	46.2	15	R3	Class T	80A	Class J	100A
ACH580-VxR-059A-2	59.4	20	R3	Class T	80A	Class J	100A
ACH580-VxR-075A-2	74.8	25	R4	Class T	100A	Class J	100A

1) "VxR" represents both VCR and VDR.

460 Volt fuses for vertical enclosures

Type Code ¹	Nominal Output Ratings		Base Drive Frame Size	Internal Drive Fuse Rating		External Fuse for Disconnect Option	
	Drive Current	Package Power		Class	Max Current Rating	Class	Max Current Rating
	A	HP					
460 Volts							
ACH580-VxR-02A1-4	2.1	1	R1	Class CC	15A	Class J	15A
ACH580-VxR-03A0-4	3.0	1.5	R1	Class CC	15A	Class J	15A
ACH580-VxR-03A5-4	3.5	2	R1	Class CC	15A	Class J	15A
ACH580-VxR-04A8-4	4.8	3	R1	Class CC	15A	Class J	15A
ACH580-VxR-07A6-4	7.6	5	R1	Class CC	15A	Class J	20A
ACH580-VxR-012A-4	12	7.5	R1	Class CC	15A	Class J	25A
ACH580-VxR-014A-4	14	10	R2	Class CC	30A	Class J	35A
ACH580-VxR-023A-4	23	15	R2	Class CC	30A	Class J	45A
ACH580-VxR-027A-4	27	20	R3	Class T	40A	Class J	60A
ACH580-VxR-034A-4	34	25	R3	Class T	60A	Class J	60A
ACH580-VxR-044A-4	44	30	R3	Class T	60A	Class J	60A
ACH580-VxR-052A-4	52	40	R4	Class T	80A	Class J	100A
ACH580-VxR-065A-4	65	50	R4	Class T	90A	Class J	100A
ACH580-VxR-077A-4	77	60	R4	Class T	100A	Class J	100A

1) "VxR" represents both VCR and VDR.

575 Volt fuses for vertical enclosures

Type Code ¹	Nominal Output Ratings		Base Drive Frame Size	Internal Drive Fuse Rating		External Fuse for Disconnect Option	
	Drive Current	Package Power		Class	Max Current Rating	Class	Max Current Rating
	A	HP					
575 Volts²							
ACH580-VxR-02A7-6	2.7	2	R2	Class CC	30A	Class J	15A
ACH580-VxR-03A9-6	3.9	3	R2	Class CC	30A	Class J	15A
ACH580-VxR-06A1-6	6.1	5	R2	Class CC	30A	Class J	15A
ACH580-VxR-09A0-6	9	7.5	R2	Class CC	30A	Class J	20A
ACH580-VxR-011A-6	11	10	R2	Class CC	30A	Class J	25A
ACH580-VxR-017A-6	17	15	R2	Class CC	30A	Class J	40A
ACH580-VxR-022A-6	22	20	R3	Class T	40A	Class J	50A
ACH580-VxR-027A-6	27	25	R3	Class T	40A	Class J	60A

1) "VxR" represents both VCR and VDR.

2) VCR is rated 600Y/347V. For use on a solidly grounded Wye source only.

208/230 Volt fuses for box enclosures

Type Code ¹	Nominal Output Ratings		Base Drive Frame Size	Internal Drive Fuse Rating		External Fuse for Disconnect Option	
	Drive Current	Package Power		Class	Max Current Rating	Class	Max Current Rating
	A	HP					
208/230 Volts							
ACH580-BxR-04A6-2	4.6	1	R1	Class CC	15A	Class J	15A
ACH580-BxR-06A6-2	6.6	1.5	R1	Class CC	15A	Class J	15A
ACH580-BxR-07A5-2	7.5	2	R1	Class CC	15A	Class J	20A
ACH580-BxR-10A6-2	10.6	3	R1	Class CC	15A	Class J	25A
ACH580-BxR-017A-2	16.7	5	R1	Class CC	30A	Class J	40A
ACH580-BxR-024A-2	24.2	7.5	R2	Class CC	30A	Class J	60A
ACH580-BxR-031A-2	30.8	10	R2	Class T	40A	Class J	60A
ACH580-BxR-046A-2	46.2	15	R3	Class T	80A	Class J	100A
ACH580-BxR-059A-2	59.4	20	R3	Class T	80A	Class J	100A
ACH580-BxR-075A-2	74.8	25	R4	Class T	100A	Class J	100A
ACH580-BxR-088A-2	88	30	R5	Class T	110A	Class J	200A
ACH580-BxR-114A-2	114	40	R5	Class T	150A	Class J	300A
ACH580-BxR-143A-2	143	50	R6	Class T	200A	Class J	350A
ACH580-BxR-169A-2	169	60	R7	Class T	250A	Class J	350A
ACH580-BxR-211A-2	211	75	R7	Class T	300A	Class J	400A
ACH580-BxR-248A-2	248	100 ²	R8	Class T	350A	Class J	400A

1) "BxR" represents both BCR and BDR.

2) 100 HP @ 230V.

460 Volt fuses for box enclosures

Type Code ¹	Nominal Output Ratings		Base Drive Frame Size	Internal Drive Fuse Rating		External Fuse for Disconnect Option	
	Drive Current	Package Power		Class	Max Current Rating	Class	Max Current Rating
	A	HP					
460 Volts							
ACH580-BxR-02A1-4	2.1	1	R1	Class CC	15A	Class J	15A
ACH580-BxR-03A0-4	3.0	1.5	R1	Class CC	15A	Class J	15A
ACH580-BxR-03A5-4	3.5	2	R1	Class CC	15A	Class J	15A
ACH580-BxR-04A8-4	4.8	3	R1	Class CC	15A	Class J	15A
ACH580-BxR-07A6-4	7.6	5	R1	Class CC	15A	Class J	20A
ACH580-BxR-012A-4	12	7.5	R1	Class CC	15A	Class J	25A
ACH580-BxR-014A-4	14	10	R2	Class CC	30A	Class J	35A
ACH580-BxR-023A-4	23	15	R2	Class CC	30A	Class J	50A
ACH580-BxR-027A-4	27	20	R3	Class T	40A	Class J	60A
ACH580-BxR-034A-4	34	25	R3	Class T	60A	Class J	60A
ACH580-BxR-044A-4	44	30	R3	Class T	60A	Class J	60A
ACH580-BxR-052A-4	52	40	R4	Class T	80A	Class J	100A

Type Code ¹	Nominal Output Ratings		Base Drive Frame Size	Internal Drive Fuse Rating		External Fuse for Disconnect Option	
	Drive Current	Package Power		Class	Max Current Rating	Class	Max Current Rating
	A	HP					
ACH580-BxR-065A-4	65	50	R4	Class T	90A	Class J	100A
ACH580-BxR-077A-4	77	60	R4	Class T	100A	Class J	100A
ACH580-BxR-096A-4	96	75	R5	Class T	150A	Class J	225A
ACH580-BxR-124A-4	124	100	R6	Class T	200A	Class J	300A
ACH580-BxR-156A-4	156	125	R7	Class T	225A	Class J	350A
ACH580-BxR-180A-4	180	150	R7	Class T	300A	Class J	350A
ACH580-BxR-240A-4	240	200	R8	Class T	350A	Class J	400A

1) "BxR" represents both BCR and BDR.

575 Volt fuses for box enclosures

Type Code ¹	Nominal Output Ratings		Base Drive Frame Size	Internal Drive Fuse Rating		External Fuse for Disconnect Option	
	Drive Current	Package Power		Class	Max Current Rating	Class	Max Current Rating
	A	HP					
575 Volts²							
ACH580-BxR-02A7-6	2.7	2	R2	Class CC	15A	Class J	15A
ACH580-BxR-03A9-6	3.9	3	R2	Class CC	15A	Class J	15A
ACH580-BxR-06A1-6	6.1	5	R2	Class CC	15A	Class J	15A
ACH580-BxR-09A0-6	9	7.5	R2	Class CC	15A	Class J	20A
ACH580-BxR-011A-6	11	10	R2	Class CC	15A	Class J	25A
ACH580-BxR-017A-6	17	15	R2	Class CC	30A	Class J	40A
ACH580-BxR-022A-6	22	20	R3	Class T	40A	Class J	50A
ACH580-BxR-027A-6	27	25	R3	Class T	40A	Class J	60A
ACH580-BxR-032A-6	32	30	R3	Class T	40A	Class J	60A
ACH580-BxR-041A-6	41	40	R5	Class T	50A	Class J	100A
ACH580-BxR-052A-6 ³	52	50	R5	Class T	80A	Class J	100A
ACH580-BxR-062A-6	62	60	R5	Class T	80A	Class J	150A
ACH580-BxR-077A-6	77	75	R5	Class T	100A	Class J	175A
ACH580-BxR-099A-6	99	100	R7	Class T	150A	Class J	225A
ACH580-BxR-125A-6	125	125	R7	Class T	175A	Class J	300A
ACH580-BxR-144A-6	144	150	R8	Class T	200A	Class J	350A

1) "BxR" represents both BCR and BDR.

2) BCR is rated 600Y/347V unless otherwise specified. For use on a solidly grounded Wye source only.

3) BCR supports Delta network configuration.

Basic control connections for E-Clipse HVAC Default

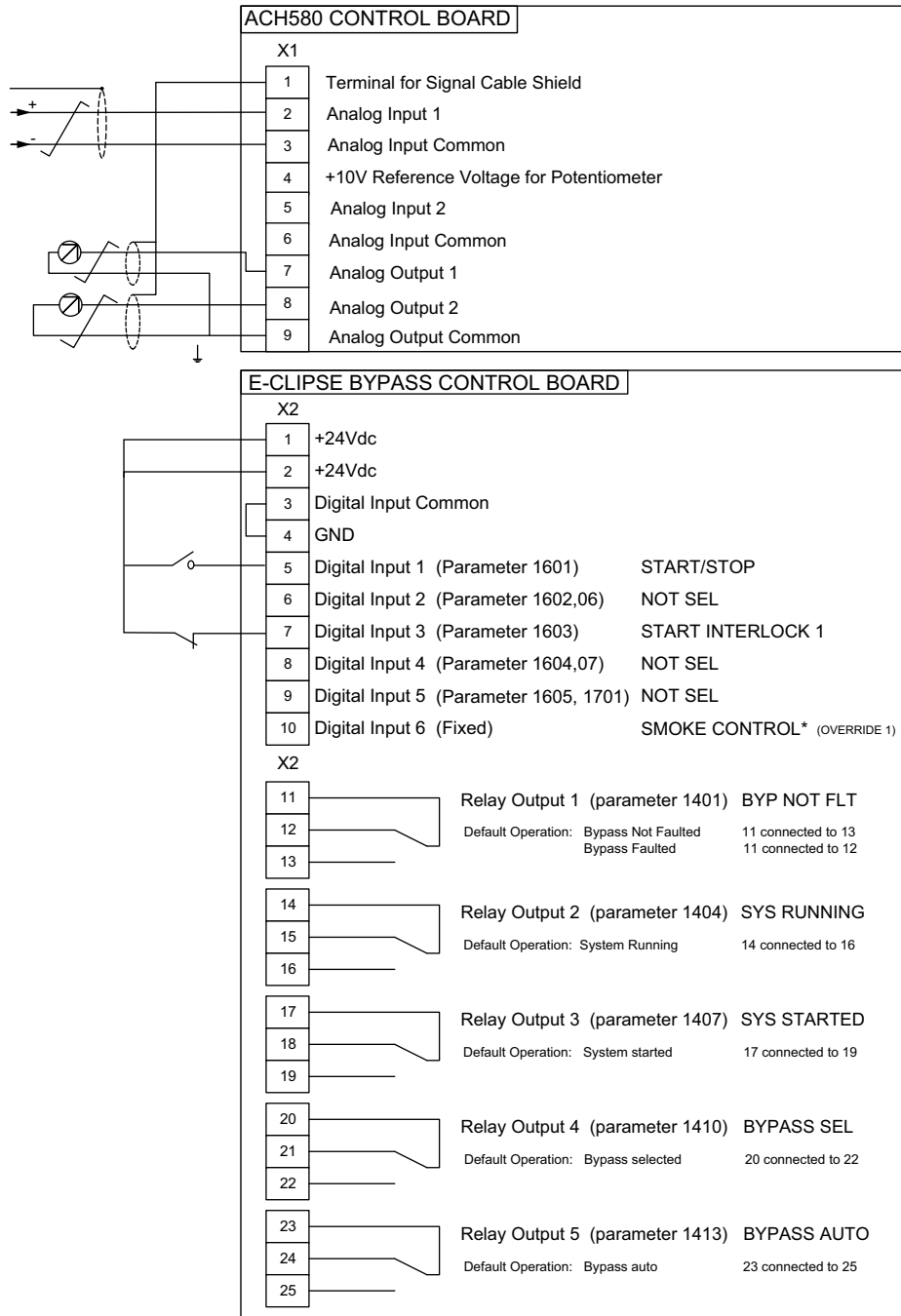

Parameters Changed Relative to E-Clipse HVAC Default

Parameter Number	Description	Setting

* Smoke Control (Override1) is a fixed input. Closing Digital Input 6 will place the E-Clipse Bypass in Smoke Control mode which may reassign the function of the other Digital Inputs. Refer to the Smoke Control (Override1) documentation.

2. Check installation – Bypass

Control panel settings and checks

Apply power to the E-Clipse Bypass unit. The ACH580 Control Panel should show the operating status of the drive. If the E-Clipse Bypass Control Panel displays a PHASE SEQ (Phase Sequence) fault, remove power, wait at least 5 minutes and then swap any two input phase wires. If the motor is a standard 240 V, 60 Hz motor connected to a 240 V drive or a 460 V, 60 Hz motor connected to a 480 V drive, the default parameter settings should be suitable for the initial tests described below. If the motor's rating is not 240 V or 460 V, 60 Hz, the Motor Nominal Voltage and Motor Nominal Frequency parameters will need to be properly set before proceeding. Refer to the *ACH580 HVAC control program firmware manual* and set the parameters as required.

Note: The settings for ALL external serial communication between the ACH580 with E-Clipse Bypass and any Building Automation System are configured using the E-Clipse Bypass operator panel. DO NOT attempt to configure the external serial communication connection using the ACH580 operator panel!

The settings for internal communication between the ACH580 and the E-Clipse Bypass are configured at the factory and require no adjustment.

Drive Link recovery procedure

If the ACH580 Drive communication settings are unintentionally changed during setup a "Drive Link Fault", "Drive Link Error" or "Drive Setup" alarm may be displayed. Should this occur, accomplish the following steps in order.

Using the ACH580 Drive Keypad, set Parameter 9521 bit 5 to "Bypass present". This will automatically set up the ACH580 to support the bypass.

System check: motor connected to ACH580 with E-Clipse Bypass

After performing the control panel checks and setting the ACH580 Drive Start-up Data parameters, check the operation of the ACH580 Drive with E-Clipse Bypass with the motor connected as follows:

1. In order to prevent the motor from starting, the system should be in the Drive mode and the drive should be OFF when the power is disconnected at the end of the previous series of control panel settings and checks.
2. Disconnect and lock out power to the E-Clipse Bypass unit, wait at least five minutes before disconnecting power.
3. Connect the motor to the output terminals.



CAUTION: Be aware of the state of the contacts before applying power.

If the Advanced Override (Override 2) input contact is closed, the motor will start across the line as soon as power is applied.

If the Start Interlock and Run Permissive input contacts are closed and the Smoke Control (Override 1) input contact is closed, the motor will start across the line as soon as power is applied.

If the Start/Stop, Start Interlock and Run Permissive input contacts are closed and the system is in the Bypass mode and in either Hand or Auto, the motor will start across the line as soon as power is applied.

If the Start/Stop, Start Interlock and Run Permissive input contacts are closed and the system is in the Drive mode with the drive in either Hand or Auto mode, the motor will start on the drive as soon as power is applied.

In order to prevent the motor from running without disconnecting the motor, open the Run Permissive and Safety Interlock contacts on bypass control board terminals X2:2, X2:3 and X2:4 before applying power. Set the bypass to Drive mode and the drive to OFF.

4. Apply power to the E-Clipse Bypass unit. The ACH580 Control Panel display should be illuminated. On the bypass control panel, both the display and Enabled LED should be illuminated. If the Enabled LED is not illuminated solid green, check to see that closed contacts or jumpers connect terminal X2:3 to X2:4 and X2:2 to X2:7 on the bypass control board.
5. The Drive Selected LED should be illuminated. If not, press the Drive Select key to switch to Drive mode. Leave the system in the Drive mode when proceeding to the next step.
6. Press the Hand key on the ACH580 Control Panel. Press and hold the UP key until the motor just starts rotating.

Note: If the ACH580 Control Panel displays an Overcurrent, Short circuit or Earth leakage fault, disconnect and lock out power to the E-Clipse Bypass unit. Wait at least 5 minutes. Disconnect the motor leads from the E-Clipse Bypass unit and Megger each motor lead to ground to determine if the motor is good. Check the power leads from the Drive / Bypass to the motor for damaged or improper wiring. If the ACH580 Control Panel displays any other drive faults, correct the fault condition before proceeding to the next step.



CAUTION: Check motor rotation direction as soon as the motor begins to move. If motor does not rotate in the correct direction, shut down the drive, disconnect and lock out power to the drive and wait five minutes. Swap any two motor output wires (T1, T2, and T3). Incorrect motor rotation direction may cause equipment damage.

7. Increase the speed to 60 Hz or the highest safe operating speed.
8. Press the OFF key on the drive control panel. The motor should stop.

If the drive does not operate according to these steps, refer to the *ACH580 HVAC control program firmware manual*.

If the drive operates according to these steps, your ACH580 with E-Clipse Bypass is ready to use with preset or modified macro settings.

Note: The settings for ALL external serial communication between the ACH580 with E-Clipse Bypass and any Building Automation System are configured using the E-Clipse Bypass operator panel. DO NOT attempt to configure the external serial communication connection using the ACH580 operator panel!

The settings for internal communication between the ACH580 and the E-Clipse Bypass are configured at the factory and require no adjustment.

Note: On the ACH580 drive, Parameter 9521, bit 5 must be set for proper operation with the E Clipse Bypass. When this bit is set, the following ACH580 parameter values are set and write protected:

Parameter	Value
20.01 – Ext1 commands	14 – Embedded fieldbus
20.02 – Ext1 start trigger type	1 – Level
20.06 – Ext2 commands	14 – Embedded fieldbus
20.07 – Ext2 start trigger type	1 – Level
20.40 – Run permissive	15 – Embedded fieldbus
20.41 – Start interlock 1	15 – Embedded fieldbus
20.42 – Start interlock 2	1 – Not used
20.43 – Start interlock 3	1 – Not used
20.44 – Start interlock 4	1 – Not used

Parameter	Value
58.01 – Protocol	1 – Modbus RTU
58.04 – Baud rate	6 – 76.8kbits/s
58.05 – Parity	2 – 8 EVEN 1
58.25 – Control profile	5 – DCU profile
58.34 – Word order	0 – HI-LO

Refer to the *ACH580-01 Firmware manual* for programming instructions.

Note: Primary Settings and E-Clipse Bypass Not to be used to configure parameters above which include:

- Start/Stop
- Interlocks & Permissive
- Communications

Note: Run motor from drive before attempting bypass operation.

System check: motor disconnected from the ACH580 with E-Clipse Bypass

If you are familiar with the E-Clipse Bypass operation, you may skip the following section. Otherwise, after performing the system checks and setting the ACH580 Drive Start-up Data parameters, become familiar with the operation of the ACH580 Drive with E-Clipse Bypass without the motor connected as follows:

1. Disconnect and lock out power to the E-Clipse Bypass unit, wait at least five minutes after disconnecting power.
2. Disconnect the motor from the E-Clipse Bypass unit.
3. Apply power to the E-Clipse Bypass unit by turning on the branch circuit disconnect device and the bypass disconnect switch or circuit breaker.
4. The ACH580 Control Panel display should be illuminated. On the E-Clipse Bypass control panel, both the display and *Enabled* LED should be illuminated. If the *Enabled* LED is not illuminated solid green, check to see that closed contacts or jumpers connect terminal X2:3 to X2:4 and X2:2 to X2:7 on the bypass control board.
5. On the E-Clipse Bypass control panel, either the *Drive Selected* or *Bypass Selected* LED should be illuminated. Pressing the *Drive Select* or *Bypass Select* key should switch the bypass back and forth between the *Drive* mode and the *Bypass* mode as indicated by the LEDs above each button. Check that the bypass control panel switches the system between modes. Leave the system in the Bypass mode when proceeding to the next step.
6. Check to see that pressing the:
 - *Auto* key on the bypass control panel causes the bottom line on the E-Clipse Bypass display to indicate “*Bypass in Auto*”.
 - *Hand* key on the bypass control panel generates a Motor Phase Fault.

- Under normal conditions (motor connected) pressing the *Hand* key on the bypass control panel causes the bottom line on the E-Clipse Bypass display to indicate “Hand #A Run”.
 - *OFF* key on the bypass control panel causes the bottom line on the E-Clipse Bypass display to indicate “Off Stop”.
7. For Steps 8 through 14, ACH580 Drive Parameter 9904 must be set to “Scalar”. After successful completion of Step 13, Parameter 9904 may be set to “Vector” if very specific application requirements make it necessary to use this type of motor control. Operation using the “Vector” setting is unnecessary for control of almost all fan and pump applications. Refer to the *ACH580 Firmware manual* for details on setting parameters.
 8. Press the *Drive Select* key on the E-Clipse Bypass
 -  control panel. The *Drive Select* LED should be illuminated.
 9. Check to see that pressing the:
 - *Auto* key on the bypass control panel causes the E-Clipse Bypass display to indicate “Bypass in Auto”.
 - *Hand* key on the bypass control panel causes no change to the E-Clipse Bypass display.
 - *OFF* key on the bypass control panel causes the E-Clipse Bypass display to indicate “Bypass in Off”.
 10. Press the *HAND* key on the drive control panel. Note that the top line of the control panel display indicates “HAND” and run as a clockwise rotating arrow. The *Drive Run* LED on the E-Clipse Bypass control panel should be illuminated.
 11. Press the *UP* arrow on the drive control panel. Note that the speed reference indication in the top line of the drive control panel display increases from “0.0% SP.”
 12. In the middle line of the drive control panel display, the output current indication should indicate “0.0 A.”
 13. Press the *DOWN* arrow on the drive control panel until the speed and frequency indications return to “0.0.”
 14. Press the *OFF* key on the drive control panel. Note that the bottom line of the drive control panel display indicates “Off.”

If the ACH580 Drive and E-Clipse Bypass operate according to these steps, and you have familiarized yourself with their operation, disconnect and lock out power to prepare for the next test.



WARNING! Frames R1 ... R3: Measure the voltage between the drive’s UDC+ terminal and grounding terminal (PE) with one multimeter. As there is no UDC- terminal, measure the voltage between the drive’s T1/U terminal and grounding terminal (PE) with another multimeter. Ensure the voltage difference between the two multimeters is near 0V.

If the drive does not operate according to these steps, refer to the *ACH580 Hardware manual*.

3. Check jumpers and switches

The settings described in this section are factory set and, for most situations, do not require adjustment. However, it is a good practice to review these settings to confirm that they are appropriate for the configuration installed.

Jumper and switch locations

The figure below shows the locations of the SW1 DIP switch on the E-Clipse Bypass control board. The function and setting of this switch is explained in the following paragraph.

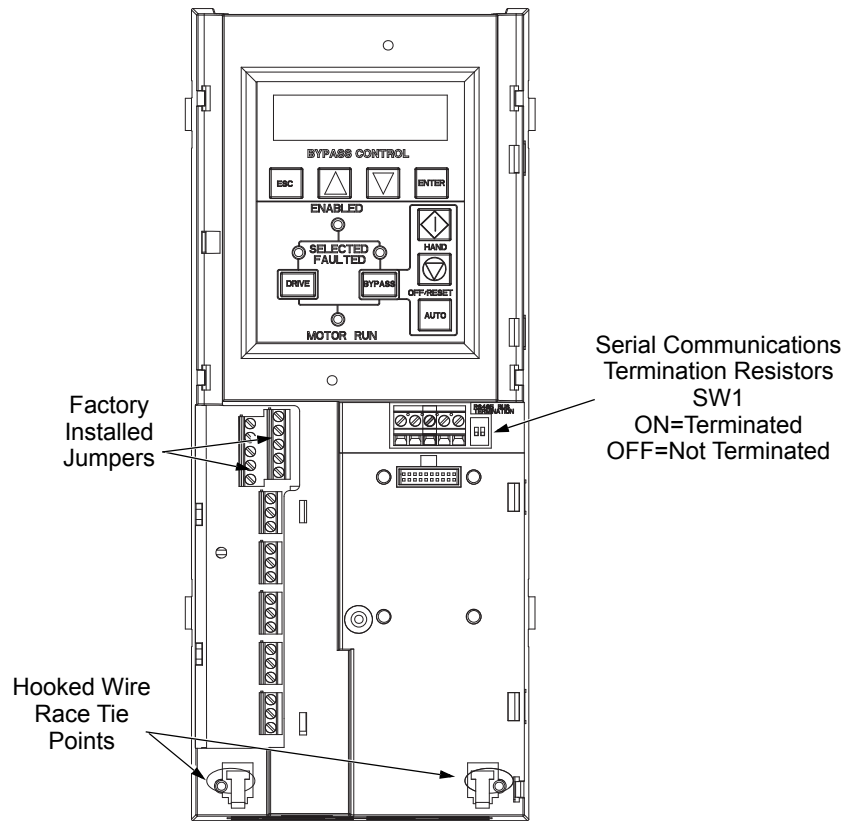

DIP switch settings

The DIP switch is used to configure the serial communications termination resistors.

To reduce noise on the serial communications network, terminate the EIA-485 network using 120 ohm resistors at both ends of the network. Use the DIP switches to connect or disconnect the on-board termination resistors. Both switches must be positioned in the ON or OFF position to correctly configure the termination resistors.

Operation

E-Clipse bypass configurations

The ACH580 with E-Clipse Bypass is an ACH580 AC adjustable frequency drive in an integrated UL (NEMA) Type 1, UL (NEMA) Type 12 or UL (NEMA) Type 3R package with a bypass motor starter. The ACH580 with E-Clipse Bypass provides:

- Disconnect switch or circuit breaker with door mounted control lever. The lever can be padlocked in the OFF position (padlock not supplied).
- Bypass starter.
- Motor overload protection.
- Local operator panel with indicating lights and multifunction display.
- Provisions for external control connections.
- Embedded communications for major BMS protocols including BACnet, Johnson Controls International N2 and Modbus.
- Optional fieldbus adapters for connection to additional BMS protocols including LonWorks and Ethernet.
- Optional drive service switch (drive input disconnect), the functional equivalent of a three-contactor bypass arrangement.

The following shows the front view of the ACH580 Vertical E-Clipse Bypass configuration and identifies the major components.

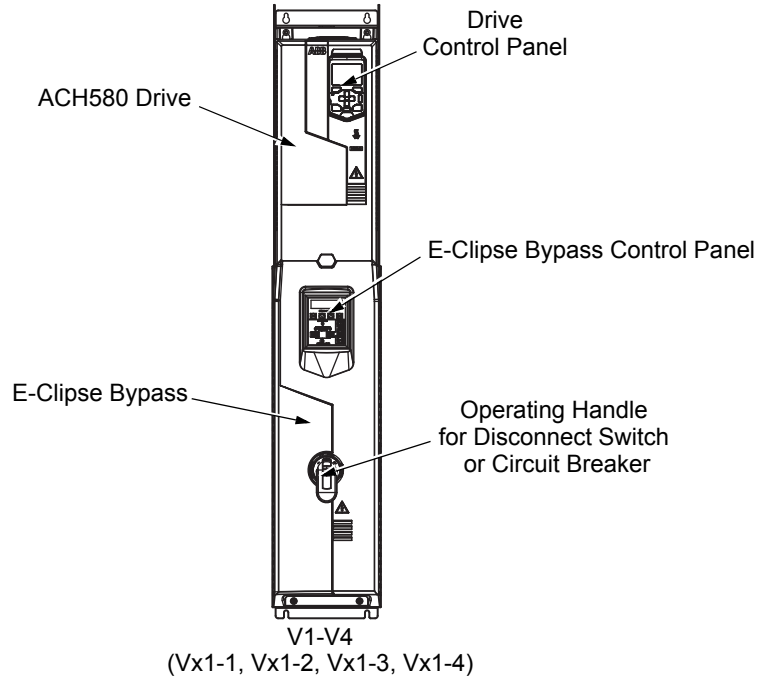

The following shows the front view of the ACH580 Box E-Clipse Bypass configurations and identifies the major components.

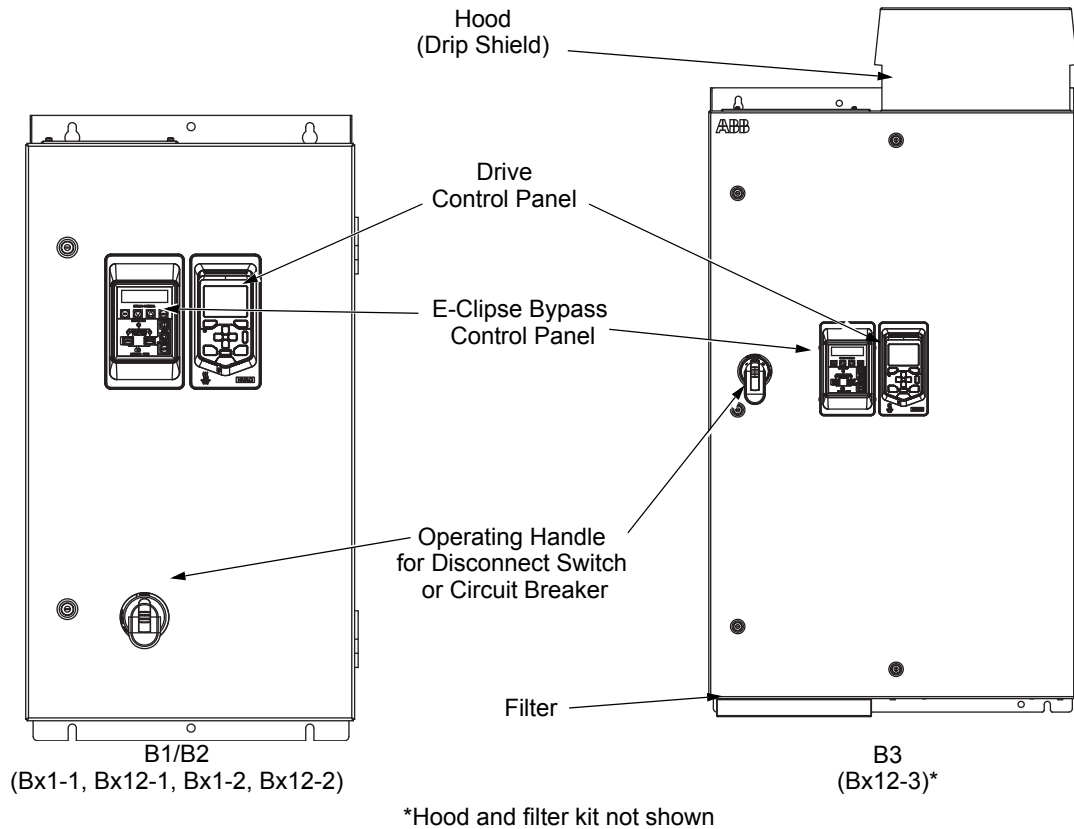

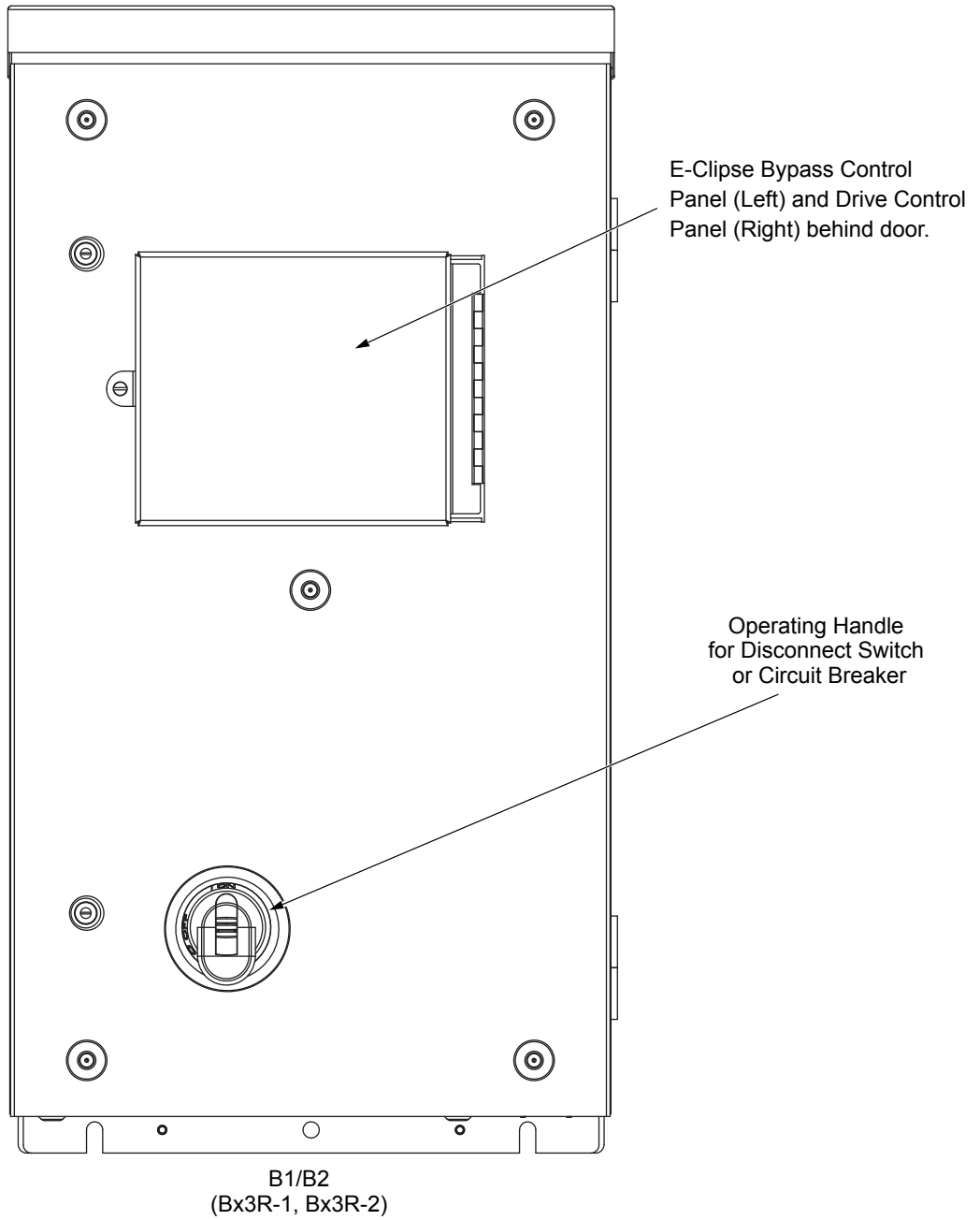

The following is a typical power diagram.

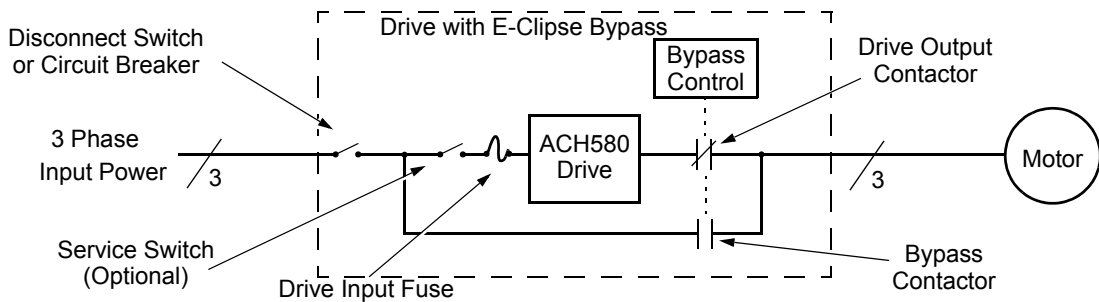

Bypass control

The bypass control panel features:

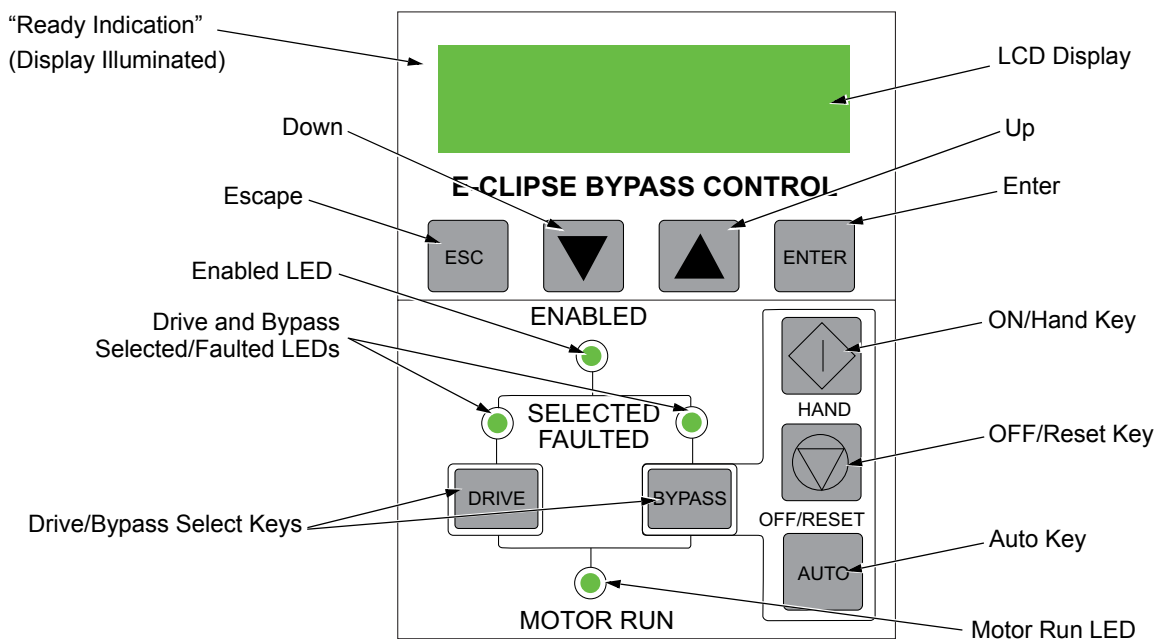

Ready (Power On) Indication

The *Ready (Power On) indication* is provided by the bypass control panel. The bypass control panel display will be illuminated and text will be displayed when the disconnect switch or circuit breaker is closed and control power is applied to the bypass.

Enabled LED

The *Enabled LED* is illuminated green under the following conditions:

- Both the Start Interlock(s) and Run Permissive contacts are closed.
- The Start Interlock contact(s) are closed with no Start command present.

The Enabled LED flashes green if the Run Permissive contact is open, the Safety Interlock contact(s) are closed, and Start command is present.

The Enabled LED is illuminated red when the Start Interlock contact(s) are open.

Motor Run LED

The *Motor Run LED* is illuminated green when the motor is running in either bypass mode or in drive mode. The Motor Run LED flashes green to indicate the system has been placed in an Override condition.

Bypass Faulted LED

The *Bypass Faulted LED* is illuminated or flashes red when the motor or bypass protection functions have shut down the bypass. The specific nature of the fault is indicated on the bypass control display. Refer to the [Diagnostics](#) section of this manual for more details.

Drive Selected LED

The *Drive Selected LED* is illuminated green when the drive has been selected as the power source for the motor and no drive fault is present.

Bypass Selected LED

The *Bypass Selected LED* is illuminated or flashes green when the bypass has been selected as the power source for the motor and no bypass fault is present.

Drive Faulted LED

The *Drive Faulted LED* is illuminated red when the bypass has lost its communications link with the drive or when the motor or drive protection functions have shut down the drive. The specific nature of the fault is indicated on the drive control panel display. Refer to the [Diagnostics](#) section on page 123 of the ACH580-UH User's Manual for more details.

Automatic Transfer

The *Automatic Transfer* indication is provided on the bypass control panel. The bypass control display will continuously flash an alarm to indicate the system has automatically transferred to Bypass after a Drive fault. The Bypass Selected LED flashes green when the system has automatically transferred to bypass operation. The bypass event log will also record this event.

Auto Indication

The *Auto Indication* is provided on the bypass control panel default display when the bypass control panel Auto key is pressed. Normally this indicates that the Auto Start contact or serial communications has been selected as the means for starting and stopping the motor in the bypass mode.

Off Indication

The *Off Indication* is provided on the bypass control panel default display when bypass control panel Off key is pressed.

Hand Indication

The *Hand Indication* is provided on the bypass control panel default display when the motor has been started manually in the bypass mode.

Drive Select Key

The *Drive Select Key* selects the drive as the power source for the motor.

Bypass Select Key

The *Bypass Select Key* selects the bypass as the power source for the motor.

Off/Reset Key

The *Off/Reset Key* may be used to manually stop the motor if the motor has been running on bypass power. The Off/Reset key also resets most bypass faults. It may take several minutes before the bypass can be reset after an overload trip. If a bypass fault condition is present the second press of this key places the bypass in the OFF mode.

Auto Key

The *Auto Key* selects the Auto Start contact or serial communications as the means for starting and stopping the motor in the bypass mode.

Hand Key

The *Hand Key* can be used to manually start the motor when the bypass has been selected as the power source for the motor.













Bypass control panel modes

The HVAC Bypass Control Panel has several different modes for configuring, operating and diagnosing the bypass. Select MENU and use the UP/DOWN buttons to select modes. The modes are:

- Default Display mode – Provides (HAND/OFF/AUTO) indication of the bypass operating control mode.
- Bypass Status mode – Provides status indications of the current system operating conditions.
- Start-Up Parameter Mode – Provides a list of parameters or operating conditions that may be configured or viewed during startup.
- Parameter List mode – Used to edit parameter values individually.
- Changed Parameter mode – Displays changed parameters.
- Bypass Fault Display mode – If there is an active bypass fault, the control panel will flash the fault number and fault diagnostic indication in English.
- Bypass Alarm Display mode – If there is an active bypass alarm, the control panel will flash the alarm number and alarm diagnostic indication in English.











Start-up by changing the parameters from the start-up list









To change the parameters, follow these steps:

1	The Default Display indicates the Bypass Control mode.		DRIVE SELECTED BYPASS IN OFF
2	Press ENTER to enter the Main Menu .		*BYPASS STATUS STARTUP PARAMS
3	Select the Startup Params with the Up/Down arrows and press ENTER .	  	BYPASS STATUS *STARTUP PARAMS
4	Select the appropriate Parameter with the Up/Down arrows and press ENTER .	  	*1601 START/STOP 1613 BP DISABLE
5	Press the Up/Down arrows to change the Parameter Value .	 	1601 START/STOP [1:DI1]
6	Press ENTER to store the modified value or press ESC to leave the Parameter Edit mode.	 OR 	*1601 START/STOP 1613 BP DISABLE
7	Press ESC to return to the Main Menu , and again to return to the Default Display .		DRIVE SELECTED BYPASS IN OFF

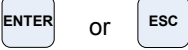
Start-up by changing the parameters individually from the parameter list

To change the parameters, follow these steps:

1	The Default Display indicates the Bypass Control mode.		DRIVE SELECTED BYPASS IN OFF
2	Press ENTER to enter the Main Menu .		*BYPASS STATUS STARTUP PARAMS
3	Select the Parameter List with the Up/Down arrows and press ENTER .	  	STARTUP PARAMS *PARAMETER LIST
4	Select the appropriate Parameter Group with the Up/Down arrows and press ENTER .	  	14 RELAY OUT *16 SYSTEM CTRL
5	Select the appropriate Parameter in a group with the Up/Down arrows and press ENTER .	  	*1601 START/STOP 1602 PERMISSIVE

6	Press the Up/Down arrows to change the Parameter Value .		
7	Press ENTER to store the modified value or press ESC to leave the Parameter Edit mode.		
8	Press ESC to return to the listing of Parameter Groups , and again to return to the Main Menu .		
9	Press ESC to return to the Default Display from the Main Menu .		

Note: In the Parameter Edit mode the current parameter value appears below the parameter name.

Note: To view the default parameter value, press the **Up/Down** arrows simultaneously. Press **Enter** to restore the default parameter value or press **ESC** to leave the **Parameter Edit** mode.

Diagnosics

Fault listing

Fault Code	Fault Name In Panel	Fault	Possible Cause	Corrective Action
3001	COIL CURR FBK	RBCU is sensing abnormal current feedback when neither contactor should be energized	Defective component on RBCU	Change RBCU
3002	BYP CONTACT STUCK	M2 contactor indicates it is not prepared to move on a power up check of the contactor or after contact is commanded to open	Defective Contactor Defective RBCU	Disconnect incoming power from unit Check if contactor armature moves freely. If armature moves freely, then change the RBCU. If armature does not move freely, then change individual contactor (M2) or the complete assembly (RCSA-0x)
3003	DRV CONTACT STUCK	M1 contactor indicates it is not prepared to move on a power up check of the contactor or after contact is commanded to open	Defective Contactor Defective RBCU	Disconnect incoming power from unit Check if contactor armature moves freely. If armature moves freely, then change the RBCU. If armature does not move freely, then change individual contactor (M1) or the complete assembly (RCSA-0x)
3004	BYPASS COIL OPEN	M2 contactor will not close when commanded to do so	Loose J8 connector on RBCU (refer to page 99 for the J7 connector location) Loose wires on contactor terminals A1 and/or A2 Bad Output on RBCU Bad Contactor	Verify that J8 connector is firmly seated. (refer to page 99 for the J7 connector location) With incoming power disconnected, check for tightness of A1 and A2 terminals Swap RBCU Change Contactor/ Assembly
3005	DRIVE COIL OPEN	M1 contactor will not close when commanded to do so	Loose J8 connector on RBCU (refer to page 99 for the J7 connector location) Loose wires on contactor terminals A1 and/or A2 Bad Output on RBCU Bad Contactor	Verify that J8 connector is firmly seated. (refer to page 99 for the J7 connector location) With incoming power disconnected, check for tightness of A1 and A2 terminals Swap RBCU Change Contactor/ Assembly

Fault Code	Fault Name In Panel	Fault	Possible Cause	Corrective Action
3006	UNDERVOLTAGE	Fault will be generated only if the drive is controlling the motor and the power to the bypass is removed before the drive shuts down. This fault is generated when the drive contactor opens while the drive is operating.	Loose J7 connector on RBCU unit (refer to page 99 for the J7 connector location) Loose input wiring Incoming power problems	Check that J7 connector is firmly seated in RBCU (refer to page 99 for the J7 connector location) Check tightness of incoming connections Check Parameter 0413 to view voltage level at time of trip Check upstream protection
3008	DRIVE AI2 LOSS	Only displayed when in Supervisory mode. Indicates that AI2 on the drive has failed.	Check connections on drive	Check connections on drive
3009	MTR OVERLOAD	Bypass opens on motor overload conditions defined in the drive	Drive Mode: Bad Motor Bad CTs Bad RBCU Bypass mode: Bad motor Bad CTs Bad RBCU Either mode: low input voltage	Check if overload condition exists Drive Mode: Refer to ACH580 manual for proper troubleshooting techniques Bypass Mode: Check that J2 connector is firmly seated in RBCU (refer to page 99 for the J7 connector location) Use clamp p meter to verify mtr current vs. display in parameter 0101 Check input voltage
3010	INP PHASE A LOSS	Fault will be generated when the bypass contactor is requested to be closed and the RBCU does not sense voltage on Phase A	Loose J7 connector (refer to page 99 for the J7 connector location) Loose wiring on Contactor assembly. Blown upstream fuse	Check J7 connector (refer to page 99 for the J7 connector location) Check yellow wire on input block Check incoming voltage, phase to ground
3011	INP PHASE B LOSS	Fault will be generated when the bypass contactor is requested to be closed and the RBCU does not sense voltage on Phase B	Loose J7 connector (refer to page 99 for the J7 connector location) Loose wiring on Contactor assembly. Blown upstream fuse	Check J7 connector (refer to page 99 for the J7 connector location) Check black wire on input block Check incoming voltage, phase to ground
3012	INP PHASE C LOSS	Fault will be generated when the bypass contactor is requested to be closed and the RBCU does not sense voltage on Phase C	Loose J7 connector (refer to page 99 for the J7 connector location) Loose wiring on Contactor assembly. Blown upstream fuse	Check J7 connector (refer to page 99 for the J7 connector location) Check red on input block Check incoming voltage, phase to ground

Fault Code	Fault Name In Panel	Fault	Possible Cause	Corrective Action
3013	DRIVE 1ST START	Fault generated if attempting to close the bypass contactor with out running the bypass in drive mode first.	NA	Run bypass unit in drive mode before attempting bypass mode
3014	COIL POW SUPPLY	Coil power supply has failed to reach rated voltage	Internal failure on RBCU unit Shorted contactor coil	Cycle power on bypass unit. If contactor coil is shorted, fault 3023 or 3024 will be generated. If 3023 or 3024 is generated, replace respective contactor If 3023 or 3024 is not generated on power up, replace RBCU unit.
3016	EARTH FAULT	Declared if attempting to close the bypass contactor when the drive has earth fault declared	Earth fault in motor	Refer to the fault code A2B3 on page 57.
3017	MTR UNDERLOAD	If motor power(%) level falls below minimum power level establish in parameter 3003 for the time (s) set in parameter 3002 fault will be generated. Parameter 3003 is a percentage of motor power as defined in the drive via parameter 9909. Fault only applies to bypass mode	Broken belt	Check load Reset bypass keypad Check fault code A780 on page 62, for further action
3018	MAX CYCLE FAULT	Supervisory Mode only. Declared if bypass contactor is closed by supervisory control 16 times within a 1 hour period.	High and low levels of hysteresis band are too tight	Check parameters 3202-3205. Increase time delays on parameters 3204 and 3205
3019	DRIVE LINK FAULT	Supervisory Mode Only. Fault generated if RS-485 link between drive and bypass stops communicating.	Bad cable/connection between drive and bypass. Drive parameter 95.21, bit 5 not set for "Bypass present"	Proper seating of cable in drive and RBCU (connector J3) Check that drive parameter 95.21, bit 5 = "Bypass present" Check drive Group 58 Follow DriveLink recovery procedure
3020	PHASE SEQ	Sequence of 3 phase voltage input is such that bypass operation will result in motor rotation opposite of drive forward operation.	Phase sequence unknown at time of wiring	Swap any two of the three input wires to the bypass unit

Fault Code	Fault Name In Panel	Fault	Possible Cause	Corrective Action
3021	PH A CURR FBK	Fault is generated when current in Phase A is detected and the bypass contactor is open	Loose CT connection Bad RBCU Bad CT	Check J2 connector for proper seating Check connector on Current Assembly Replace RBCU Replace RCSA unit
3022	PH C CURR FBK	Fault is generated when current in Phase C is detected and the bypass contactor is open	Loose CT connection Bad RBCU Bad CT	Check J2 connector for proper seating Check connector on Current Assembly Replace RBCU Replace RCSA unit
3023	BYP COIL SHORTED	Coil characteristics are checked only on power up and coil current is greater than allowable values	Shorted contactor coil Shorted/damaged cable Bad RBCU	Replace RBCU Replace RCSA unit
3024	DRV COIL SHORTED	Coil characteristics are checked only on power up and coil current is greater than allowable values	Shorted contactor coil Shorted/damaged cable Bad RBCU	Replace RBCU Replace RCSA unit
3027	INVALID SUB ASM	Contactor assembly as recorded in the RBCU unit does not match drive information communicated via 485 link	RBCU unit from a different size bypass used to replace a defective RBCU. Parameters not matched after Firmware change.	Contact ABB at 1-800-752-0696 option 1
3028	EXT COMM LOSS	Time between fieldbus messages has exceeded timeout interval set with parameter 3005	Incorrect Communication settings in Group 51 & 53. Poor Connections Noise on Communication Line	Check Group 51 & 58 Tighten Connections Check Communication Cable Grounding
3029	EFB CONFIG FILE	Error reading configuration file for embedded fieldbus	Internal Startup error	Cycle Power Replace RBCU
3030	FORCE TRIP	Fault trip forced by external fieldbus	Overriding Control System tripped E-Clipse unit via fieldbus.	Check Overriding Control System
3031 ... 3033	EFB 1...EFB 3	Fault code reserved for embedded fieldbus.	For Bacnet: Device object instances for the drive and or bypass are set greater than 4194302 in parameters 5011 5017 and or 5311 5317 respectively	Check Parameters 5011, 5017 and/or 5811, 5817
3034	MTR PHASE	Detects open motor phase. Detection is done by current transformers in bypass unit.	Internal problem Cable problem Motor problem	Check wiring in E-Clipse Unit Check motor cabling Check Motor Check if 3006 is Disabled

Fault Code	Fault Name In Panel	Fault	Possible Cause	Corrective Action
3037	PCB TEMP	RBCU unit has reached 190 degrees Fahrenheit, 88 degrees Celsius	Cabinet cooling has failed Ambient conditions too high Bad RBCU unit	Stop drive and let cool down and restart Add additional cooling Replace RBCU
3038	NO DRIVE DATA	No drive data available	Bypass not able to extract drive data on initial power up due to: Bad cable/connection between drive and bypass. Drive parameter 95.21, bit 5 not set for "Bypass present"	Proper seating of cable in drive and RBCU (connector J3) Check that drive parameter 95.21, bit 5 = "Bypass present" Check drive Group 58 Follow DriveLink recovery procedure then cycle power to bypass.
3039	FBA PAR CONF	Non embedded fieldbus has detected an error in Group 51 parameters	Incorrect settings in Group 51	Verify Group 51 parameters
3101	SFLASH CORRUPT	Internal checksum error	NA	Cycle power Replace RBCU Upgrade firmware
3102	PMP FILE	Parameter file is corrupt		Cycle Power Contact ABB with information that preceded fault
3201	T1 OVERLOAD	T1 program cycle is overloaded	NA	Contact ABB with information that preceded fault Cycle Power Replace RBCU
3202	T2 OVERLOAD	T2 program cycle is overloaded	NA	Contact ABB with information that preceded fault Cycle Power Replace RBCU
3203	T3 OVERLOAD	T3 program cycle is overloaded	NA	Contact ABB with information that preceded fault Cycle Power Replace RBCU
3204	STACK OVERFLOW	Program cycle is overloaded	NA	Contact ABB with information that preceded fault Cycle Power Replace RBCU
3205	UNKNOWN CB	Bypass control board type is unknown.	NA	Contact ABB with information that preceded fault
3206	UNKNOWN DRIVE	Drive reports rating not found in bypass software	Drive does not match drives configured in bypass RBCU	Replace RBCU or reload with most current firmware

Fault Code	Fault Name In Panel	Fault	Possible Cause	Corrective Action
3207	UNKNOWN BYPASS	NA	NA	Replace RBCU or load most current firmware Contact ABB at 1-800-752-0696 option 1 Replace RBCU or load most current firmware

Warning listing

The following table lists the warnings by code number and describes each.

Warning Code	Warning Name In Panel	Warning	Possible Cause	Corrective Action
4001	INP PHASE A LOSS	Warning will occur in drive mode. In bypass, warning will occur if bypass contactor has not closed. Unit will trip on Fault 3010 if the bypass contactor is closed	Loose J8 connector Loose wiring on Contactor assembly. Blown upstream fuse	Check J8 connector Check yellow wire on input block Check incoming voltage, phase to ground
4002	INP PHASE B LOSS	Warning will occur in drive mode. In bypass, warning will occur if bypass contactor has not closed. Unit will trip on Fault 3011 if the bypass contactor is closed	Loose J8 connector Loose wiring on Contactor assembly. Blown upstream fuse	Check J8 connector Check black wire on input block Check incoming voltage, phase to ground
4003	INP PHASE C LOSS	Warning will occur in drive mode. In bypass, warning will occur if bypass contactor has not closed. Unit will trip on Fault 3012 if the bypass contactor is closed	Loose J8 connector Loose wiring on Contactor assembly. Blown upstream fuse	Check J8 connector Check red wire on input block Check incoming voltage, phase to ground
4004	AUTO TRANSFER	Message is displayed when the drive faults and the bypass switches to bypass mode as configured in Parameter 1608	Drive fault	Check drive
4005	EXT COMM ERR	Time between fieldbus messages has exceeded timeout interval set with parameter 3005	Incorrect Communication settings in Group 51 & 53. Poor Connections Noise on Communication Line	Check Group 51 & 58 Tighten Connections Check Communication Cable Grounding
4006	Selected by PAR 1620: PERMISSIVE DAMPER END SWITCH VALVE OPENING PRE-LUBE CYCLE	Warning will occur when start order is given and the "Permissive" is not present	Permissive condition is not satisfied. Bad 24v supply Bad digital input	Check 24 Volts on RBCU unit Check for 24 volts on respective DI when condition is satisfied Check Parameter 0103 for status of digital input
4007	PCB TEMP	RBCU unit reached 181 degrees Fahrenheit, 83 degrees Celsius	Cabinet cooling has failed Ambient conditions too high Bad RBCU unit	Stop drive and let cool down and restart Add additional cooling Replace RBCU

Warning Code	Warning Name In Panel	Warning	Possible Cause	Corrective Action
4008	DRIVE SETUP	Warning generated when configuration of drive is such that bypass can not properly control the drive. Specifically, drive parameters 10.01, 10.02, 16.01, 16.08	Incorrect parameters settings	Check that drive parameter 95.21, bit 5 = "Bypass present"
4009	BYPASS RUN DELAY	Warning is generated when a bypass start command is issued and there is non zero time value in bypass parameter 1614	NA	NA
4010	MTR OVERLOAD	Bypass warning if motor overload conditions exist as defined in the drive	Drive Mode: Bad Motor Bad CTs Bad RBCU Bypass mode: Bad motor Bad CTs Bad RBCU Either mode: low input voltage	Drive Mode: Refer to ACH580 manual for proper troubleshooting techniques Bypass Mode: Check that J2 connector is firmly seated in RBCU Check input voltage Does overload condition exist?
4011	MTR UNDERLOAD	Warning comes at half the time of a mtr underload fault. See fault 3017 for further text	NA	Parameter 3002 is the time Parameter 3003 is the level
4012	BYPASS DISABLED	Warning will be generated if parameter 1613 is set to "Disable"	NA	NA
4013	DRIVE LINK ERROR	Same as Fault 3019 however will occur when not in supervisory mode	Bad cable between drive and bypass Drive parameter 95.21, bit 5 not set for "Bypass present"	Proper seating of cable in drive and RBCU (connector J3) Check that drive parameter 95.21, bit 5 = "Bypass present" Follow DriveLink recovery procedure
4014	DRIVE TEST	Warning is generated when bypass parameter 1617 is set to "enable"	NA	NA
4015	START DRIVE 1ST	Message displayed on initial "out of box" power up sequence	NA	Run drive in Hand

Warning Code	Warning Name In Panel	Warning	Possible Cause	Corrective Action
4016	INP VOLTAGE LOW	3-Phase input voltage has not reached a sufficient level to enable editing of parameters via the keypad. This message is generated within a few seconds of power up	NA	Loose J7 connector Low input voltage. Incoming voltage has not reached at least 155 VAC within a few seconds of powerup
4019	OVERRIDE 1	Warning is generated when override 1 is active	NA	Check Parameter 0103 and 0104 for digital input status
4020	OVRD2 BYP	Warning is generated when override 2 is active and the bypass is controlling the motor	NA	Check Parameter 0103 and 0104 for digital input status
4021	Selected by PAR 1621 INTERLOCK 1 VIBRATION SWITCH FIRESTAT FREEZESTAT OVERPRESSURE VIBRATION TRIP SMOKE ALARM SAFETY OPEN LOW SUCTION PRES	Warning will occur when start order is given and the "Permissive" is not present	Permissive condition is not satisfied. Bad 24v supply Bad digital input 24 V common is not tied to Digital input common on bypass when using external 24 v supply	Check 24 Volts on RBCU unit Check for 24 volts on respective DI when condition is satisfied Check Parameter 0103 For status of digital input
4022	Selected by PAR 1622 INTERLOCK 2 VIBRATION SWITCH ... LOW SUCTION PRES	Warning will occur when start order is given and the "Permissive" is not present	Permissive condition is not satisfied. Bad 24v supply Bad digital input 24 V common is not tied to Digital input common on bypass when using external 24 v supply	Check 24 Volts on RBCU unit Check for 24 volts on respective DI when condition is satisfied Check Parameter 0103 For status of digital input
4023	Selected by PAR 1623 INTERLOCK 3 VIBRATION SWITCH ... LOW SUCTION PRES	Warning will occur when start order is given and the "Permissive" is not present	Permissive condition is not satisfied. Bad 24v supply Bad digital input 24 V common is not tied to Digital input common on bypass when using external 24 v supply	Check 24 Volts on RBCU unit Check for 24 volts on respective DI when condition is satisfied Check Parameter 0103 For status of digital input

Warning Code	Warning Name In Panel	Warning	Possible Cause	Corrective Action
4024	Selected by PAR 1624 INTERLOCK 4 VIBRATION SWITCH ... LOW SUCTION PRES	Warning will occur when start order is given and the "Permissive" is not present	Permissive condition is not satisfied. Bad 24v supply Bad digital input 24 V common is not tied to Digital input common on bypass when using external 24 v supply	Check 24 Volts on RBCU unit Check for 24 volts on respective DI when condition is satisfied Check Parameter 0103 For status of digital input
4025	LOCAL DISABLED	Warning is displayed if MODE LOCK (16.29) is set to AUTO MODE and the Hand or Off key is pressed		
4026	AUTO DISABLED	This warning is displayed if MODE LOCK (1629) is set to LOCAL MODE and the Auto key is pressed.		
4027	COMM CONFIG ERR	Warning is displayed if the drive and bypass MAC addresses are equal or invalid.	E-Clipse parameters 5002 (BP MAC ID) & 5802 (DV MAC ID) are set to the same value	Change MAC address to unique values
4028	FBA PAR CONF	Non embedded fieldbus has detected an error in Group 51 parameters		Verify Group 51 parameters
4029	DRIVE FAULTED	The drive is faulted.		Reset drive
4030	OVRD2 VFD	Warning is generated when override 2 is active and the drive is controlling the motor	NA	Check Parameter 0103 and 0104 for digital input status
4031	OVRD2 STOP	Warning is generated when override 2 is active and both the bypass and drive output contactors are deenergized	NA	Check Parameter 0103 and 0104 for digital input status

Bypass status listing

Bypass Status (16 Characters)	Condition	Description
DRIVE/BYPASS?	DRIVE SELECTED BYPASS SELECTED	Displays which one is selected, drive or bypass
SAFETIES?	OPEN CLOSED	Displays if safeties (=INTERLOCK 1 and/or INTERLOCK 2) have been applied, or if they are missing
RUN PERMISSIVES?	OPEN CLOSED	Displays if PERMISSIVE is present or not
START REQUEST?	NOT PRESENT PRESENT	Displays if start request has been applied to the system
AUTO TRANSFER?	NOT TRANSFERRED TRANSFERRED	Displays if the system is in Auto Transfer state or not. Does not reflect to PAR 16.08 AUTO XFER value itself
BYP OVERRIDE 1?	NOT ACTIVATED ACTIVATED	Status of Override 1
BYP OVERRIDE 2?	NOT ACTIVATED ACTIVATED	Status of Override 2
DRIVE FAULTED?	NO YES	Displays if drive is faulted or not
BYPASS FAULTED?	NO YES	Displays if bypass is faulted or not
SYSTEM STARTED?	NO YES	Displays if system is started or not
SYSTEM RUNNING?	NO YES	Displays if system is running or not
BYPASS WARNINGS?	NO WARNINGS WARNING ACTIVE	Displays if there is an active warning(s) in bypass or not
HAND/OFF/AUTO?	OFF MODE HAND MODE AUTO MODE	Displays operating mode of the bypass - OFF, HAND or AUTO

Error messages

#	Error Message	Description
1	CAN'T EDIT PAR IS READ ONLY	Try to save value (=press the ENTER key in Parameter Edit State) of a read-only parameter. E.g. try to change value PAR 01.02 INPUT VOLT
2	CAN'T EDIT WHEN STARTED	Try to change value of a parameter, which is allowed to be changed only when system is not started. E.g. PAR 16.02 PERMISSIVE
3	CAN'T EDIT UP+DOWN ONLY	Try to change value of a "reset only" parameter other than zero. UP+DOWN buttons must be pressed simultaneously for requesting default value of the PAR on the display (value zero), and after that ENTER pressed for saving it (reset the parameter). E.g. PAR 04.01 LAST FAULT
4	CAN'T EDIT INP VOLTAGE LOW	Input voltage too low. Changing of parameters prohibited since system cannot save values to nv-mem w/ insufficient voltage.
5	CAN'T EDIT PAR IS HIDDEN	Try to save value (=press the ENTER key in Parameter Edit State) of a hidden parameter. Should not be possible. If hidden parameters are turned visible, this message is not given.
6	CAN'T EDIT UNDER LO-LIMIT	Try to save value which is over LO-LIMIT of the parameter. Should not be possible when changing parameters from control panel.
7	CAN'T EDIT UNDER HI-LIMIT	Try to save value which is over HI-LIMIT of the parameter. Should not be possible when changing parameters from control panel.
8	CAN'T EDIT ENUM VAL ONLY	Try to save value which is out of enumerated value list. Should not be possible when changing parameters from control panel.
9	CAN'T EDIT NO DEFAULT	Try to request default value (=press UP and DOWN buttons simultaneously) for a parameter which is defined not to have a default value. Should not be possible when changing parameters from control panel.
10	CAN'T EDIT TRY AGAIN.	Parameter system is busy, e.g. application macro change is in process at the same time when someone is trying to save a value for a parameter. Should not be possible when changing parameters from control panel.

Maintenance

See [Maintenance](#) for the ACH580-01 on page [81](#) and PCR, PDR on page [150](#).

ACH580-PCR/PDR

Installation

This information is unique to ACH580 input disconnect configurations (PCR or PDR). The ACH580 with Input Disconnect is an ACH580 AC adjustable frequency drive packaged with an input disconnect switch or circuit breaker. Refer to the [Installation](#) instructions on page 8, for all other information. **Failure to observe the warnings and instructions may cause a malfunction or personal hazard.**



WARNING! Before you begin read [Safety instructions](#) on page 2.



WARNING! When the ACH580 with Input Disconnect is connected to the line power, the Motor Terminals T1, T2, and T3 are live even if the motor is not running. Do not make any connections when the ACH580 with Input Disconnect is connected to the line. Disconnect and lock out power to the drive before servicing the drive. Failure to disconnect power may cause serious injury or death.

1. Install wiring



WARNING!

- Metal shavings or debris in the enclosure can damage electrical equipment and create a hazardous condition. Where parts, such as conduit plates require cutting or drilling, first remove the part. If that is not practical, cover nearby electrical components to protect them from all shavings or debris.
- Do not connect or disconnect input or output power wiring, or control wires, when power is applied.
- Never connect line voltage to drive output Terminals T1, T2, and T3.
- Do not make any voltage tolerance tests (Hi Pot or Megger) on any part of the unit. Disconnect motor wires before taking any measurements in the motor or motor wires.
- Make sure that power factor correction capacitors are not connected between the drive and the motor.

Enclosure Designation	Horsepower Range by Voltage Range		
	208V	460V	575V ²
P1	1 to 5 HP	1 to 7.5 HP	N/A
P2	10 HP	10 to 15 HP	2 to 15 HP
P3	15 to 20 HP	20 to 30 HP	20 to 30 HP
P4	25 HP	40 to 60 HP	N/A
PB1	1 to 7.5 HP	1 to 15 HP	2 to 15 HP
PB2	10 to 25 HP	20 to 60 HP	20 to 30 HP
PB3	30 to 100 HP ¹	75 to 200 HP	40 to 150 HP

1) 100 HP @ 230V.

2) VCR and BCR are rated 600Y/347V unless otherwise specified. For use on a solidly grounded Wye source only.

Connection diagrams – Vertical Packaged Drive with input disconnect

ACH580 Vertical Packaged Drive units are configured for wiring access from the bottom only. The following figures show the layout and wiring connection points. For drive control wiring see pages 29-41. Maintain appropriate separation of control and power wires.

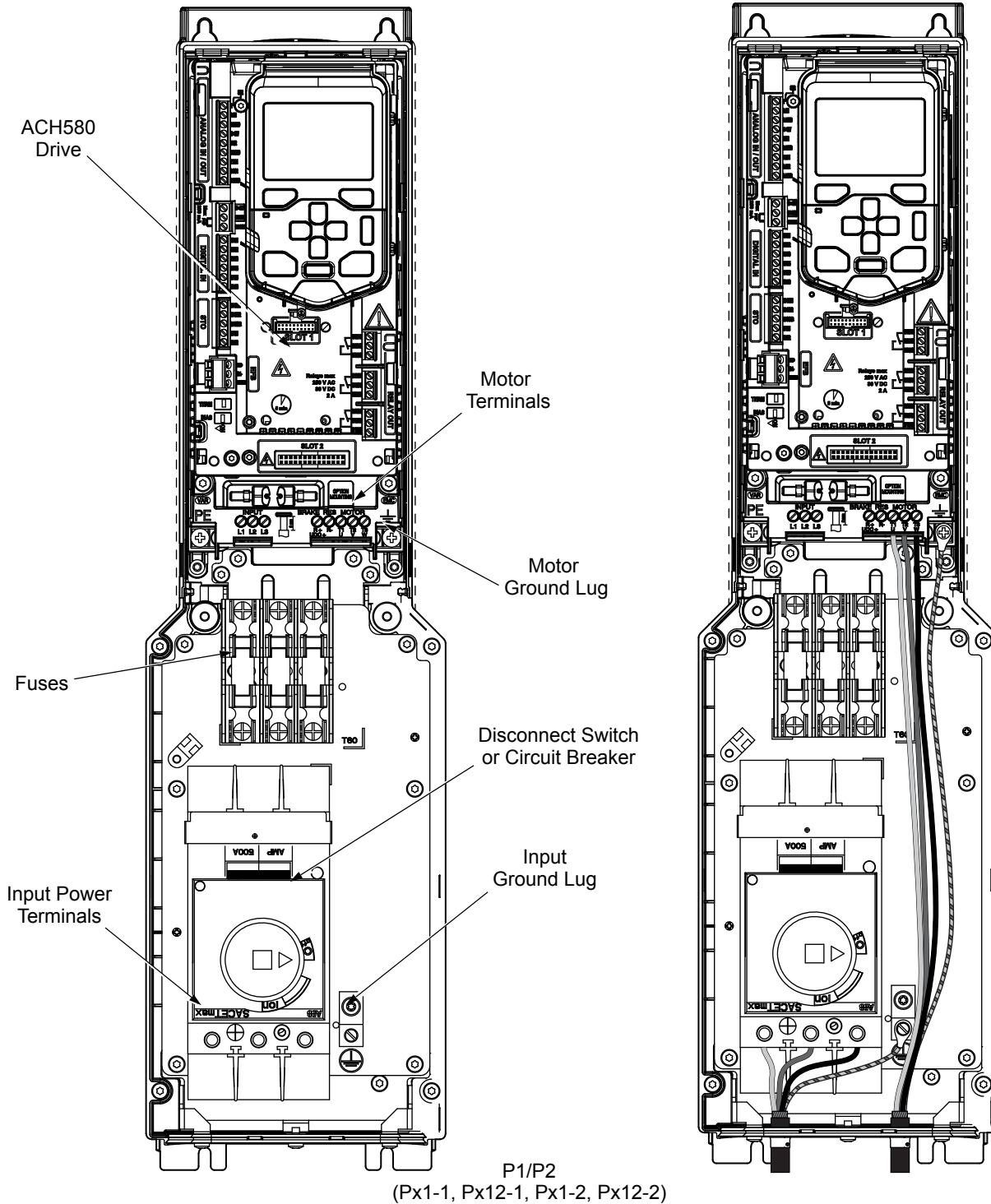

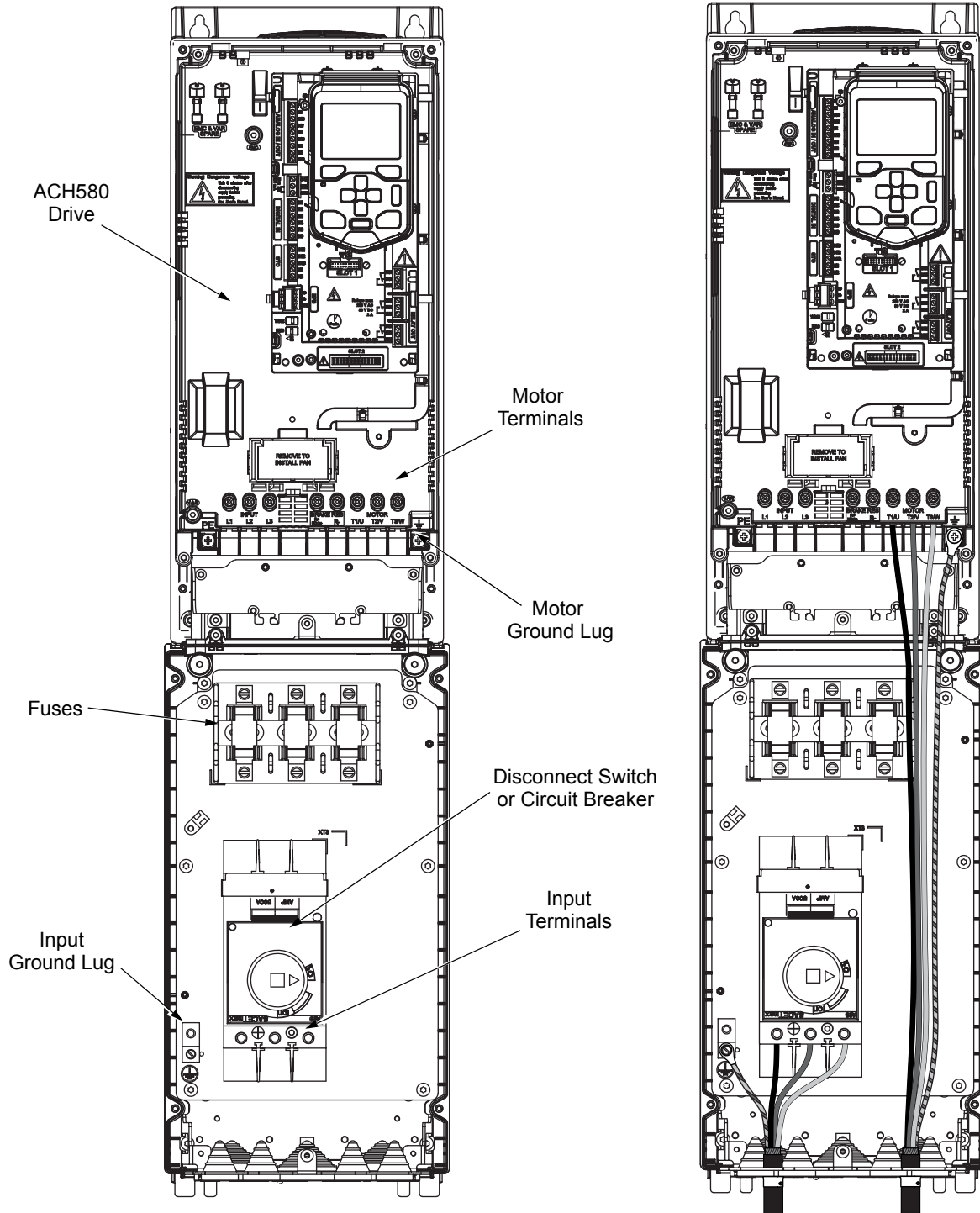

P3/P4
(Px1-3, Px12-3, Px1-4, Px12-4)

Connection diagrams – Box Packaged Drive with input disconnect

ACH580 Vertical Packaged Drive units are configured for wiring access from the top (for UL (NEMA) Type 1 and 12) and from the bottom (for UL (NEMA) Type 3R). The following figures show the layout and wiring connection points. For drive control wiring see pages 29-41.

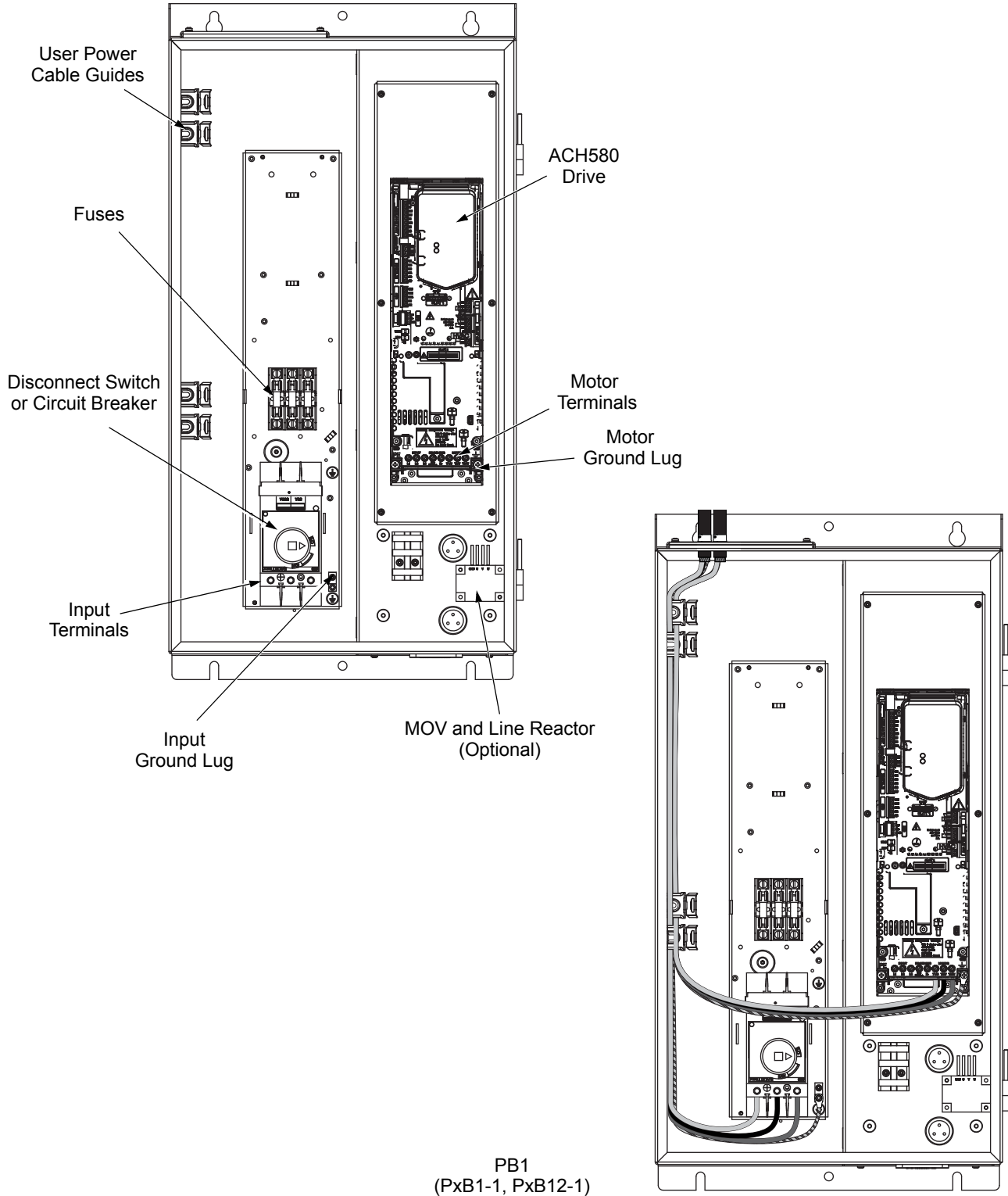

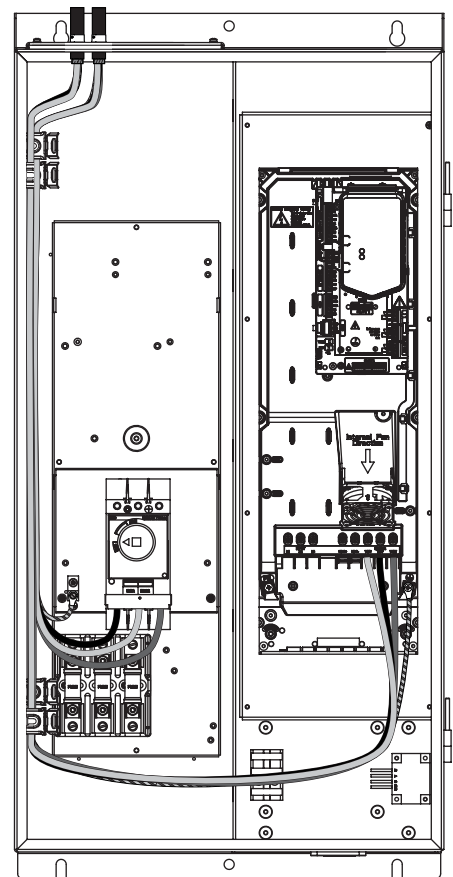
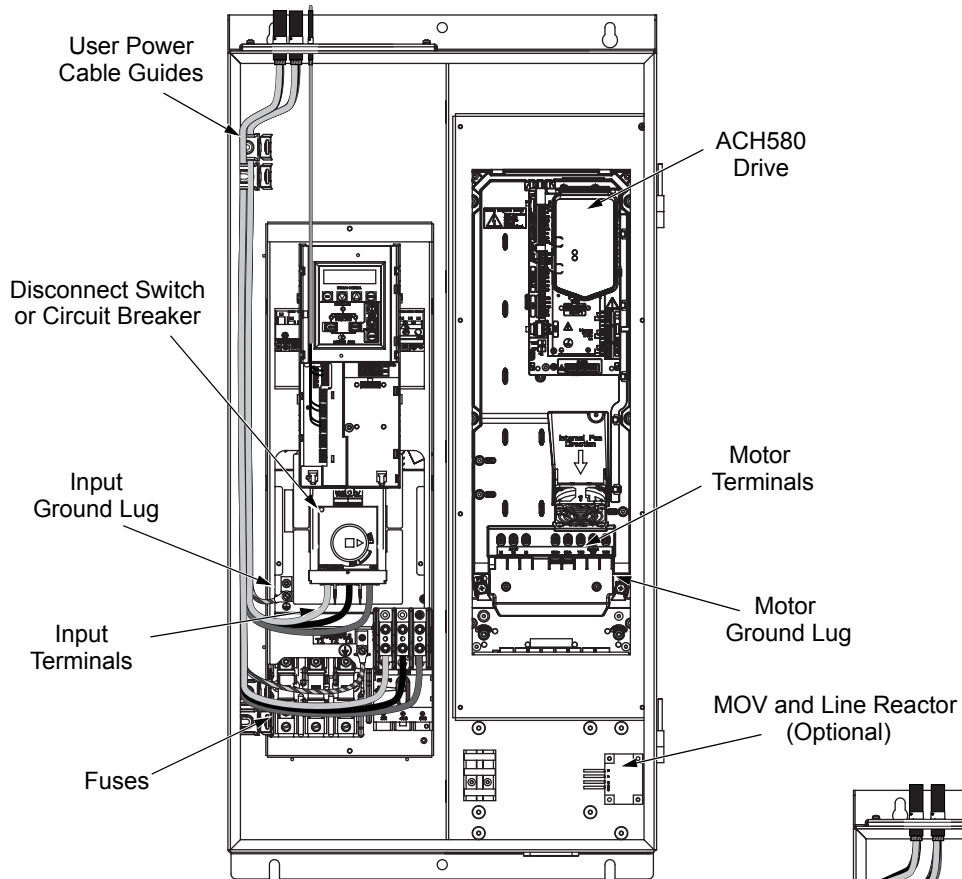

PB2
(PxB1-2, PxB12-2)

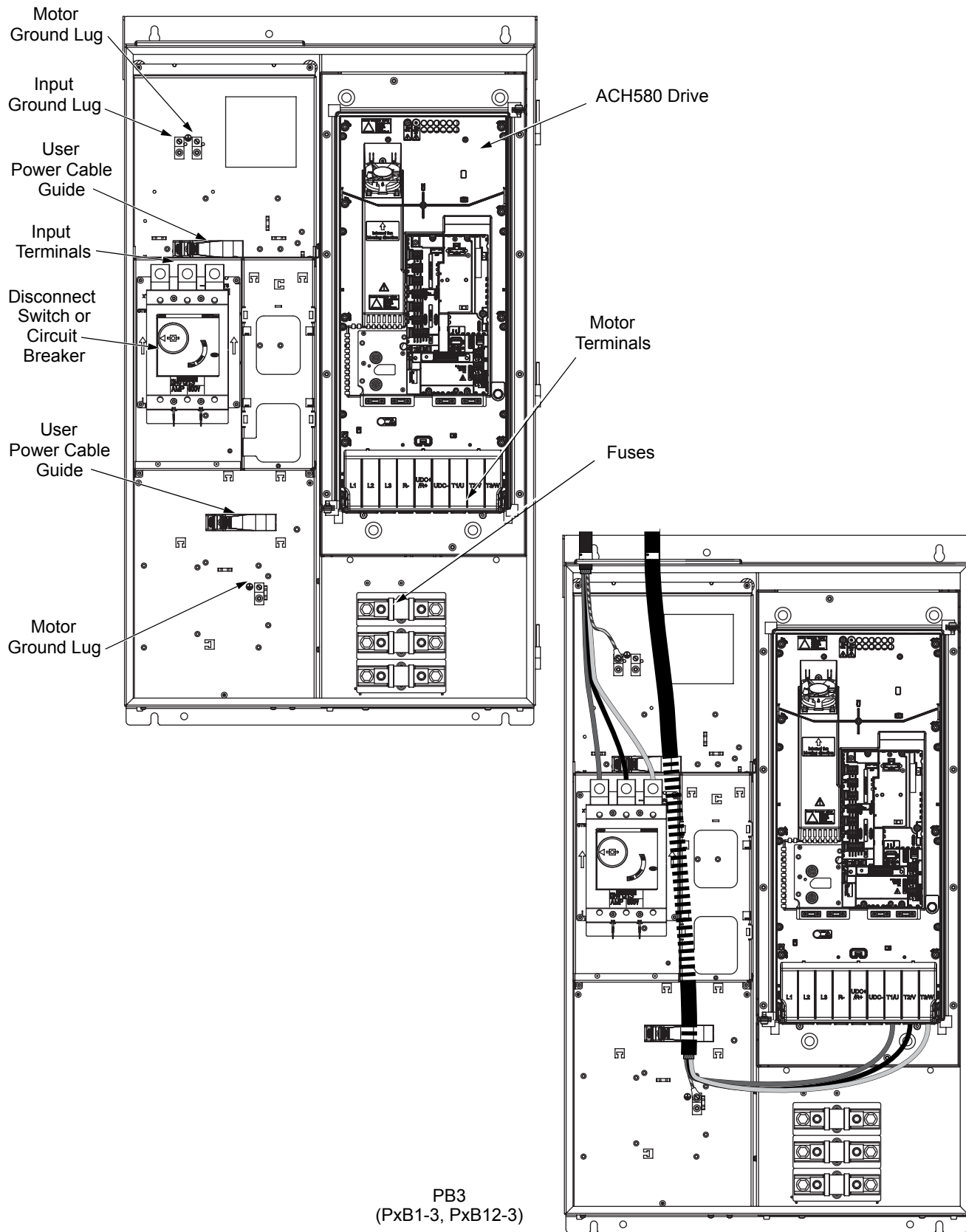

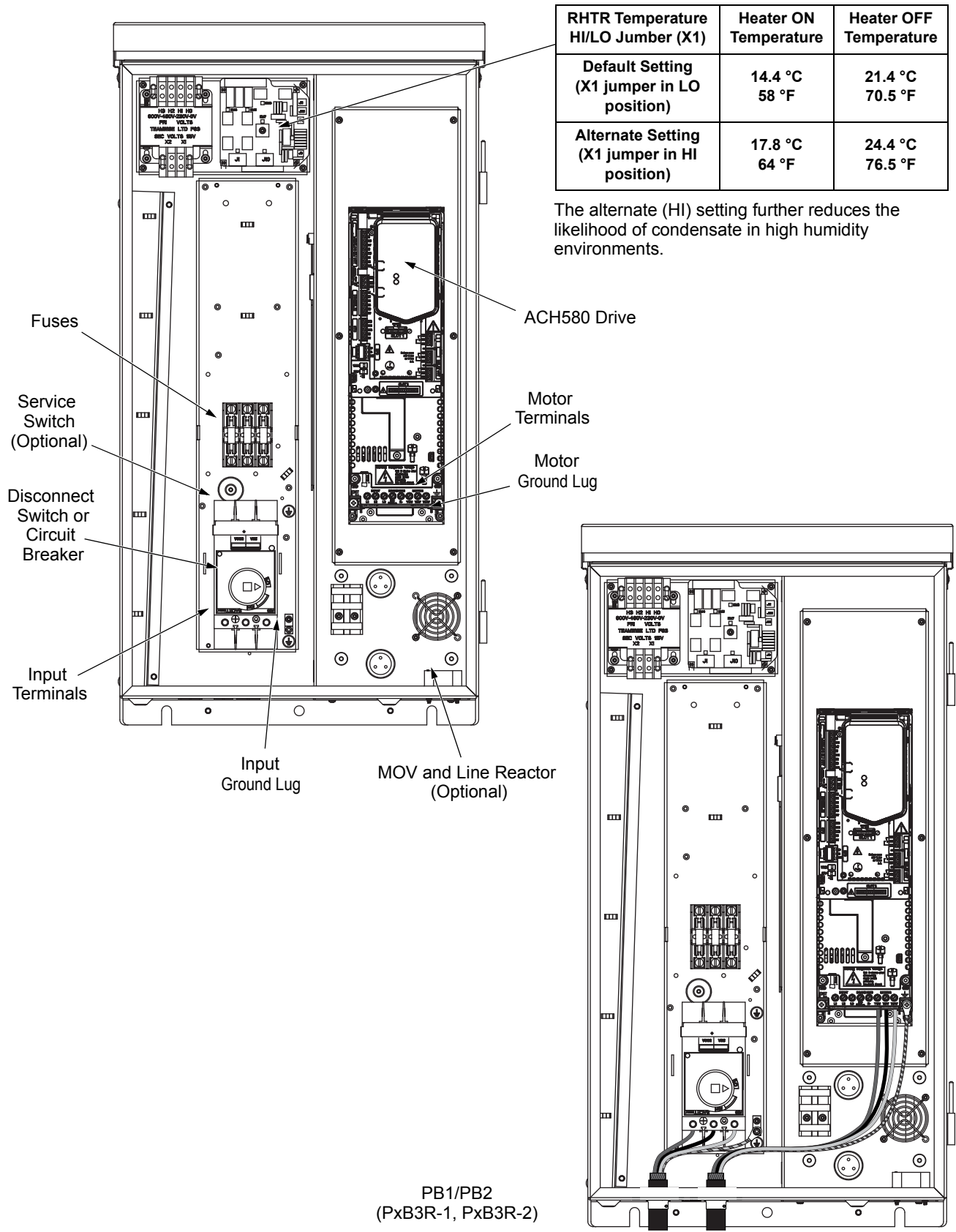

Power connection terminals

The following tables show maximum wire size and required tightening torque for incoming power, grounding and motor terminals. 1)“PxR” represents both PCR and PDR.

208/230 Volt	Output Ratings		Base Drive Frame Size	Maximum Power Wiring Data						
	Type Code ¹	A		HP	Circuit Breaker UL (NEMA) Type 1 and 12	Circuit Breaker UL (NEMA) Type 3R	Disconnect Switch UL (NEMA) Type 1 and 12	Disconnect Switch UL (NEMA) Type 3R	Motor Terminals	Ground Lugs UL (NEMA) Type 1 and 12
ACH580-PxR-04A6-2	4.6	1	R1	#10 62 in-lbs	#10 62 in-lbs	#10 55 in-lbs	#10 55 in-lbs	#10 0.7 ft-lbs	#2 50 in-lbs	#2 50 in-lbs
ACH580-PxR-06A6-2	6.6	1.5	R1							
ACH580-PxR-07A5-2	7.5	2	R1							
ACH580-PxR-10A6-2	10.6	3	R1							
ACH580-PxR-017A-2	16.7	5	R1	#6 62 in-lbs	#6 62 in-lbs	#6 55 in-lbs	#6 55 in-lbs	#6 1.1 ft-lbs		
ACH580-PxR-024A-2	24.2	7.5	R2							
ACH580-PxR-031A-2	30.8	10	R2							
ACH580-PxR-046A-2	46.2	15	R3	#2 62 in-lbs	#2 62 in-lbs	#2 55 in-lbs	#2 55 in-lbs	#2 2.6 ft-lbs		
ACH580-PxR-059A-2	59.4	20	R3							
ACH580-PxR-075A-2	74.8	25	R4	#1/0 62 in-lbs	#1/0 62 in-lbs	#1/0 55 in-lbs	#1/0 55 in-lbs	#1 3.0 ft-lbs		
ACH580-PxR-088A-2	88	30	R5	#2/0 124 in-lbs	Consult Factory	#2/0 275 in-lbs	Consult Factory	#2/0 4.1 ft-lbs		
ACH580-PxR-114A-2	114	40	R5	#1/0 124 in-lbs		#4/0 275 in-lbs				
ACH580-PxR-143A-2	143	50	R6	#3/0 124 in-lbs		200 MCM 275 in-lbs		300 MCM 22.1 ft-lbs		
ACH580-PxR-169A-2	169	60	R7	#4/0 124 in-lbs		2 X 500 MCM 274 in-lbs		500 MCM 29.5 ft-lbs		
ACH580-PxR-211A-2	211	75	R7	2 X 500 MCM 274 in-lbs						
ACH580-PxR-248A-2	248	100 ²	R8	373 MCM 274 in-lbs				2 x 300 MCM 29.6 ft-lbs		

1) “PxR” represents both PCR and PDR.

2) 100 HP @ 230V.

1) "PxR" represents both PCR and PDR.

460 Volt	Output Ratings		Base Drive Frame Size	Maximum Power Wiring Data						
	Type Code ¹	A		HP	Circuit Breaker UL (NEMA) Type 1 and 12	Circuit Breaker UL (NEMA) Type 3R	Disconnect Switch UL (NEMA) Type 1 and 12	Disconnect Switch UL (NEMA) Type 3R	Motor Terminals	Ground Lugs UL (NEMA) Type 1 and 12
ACH580-PxR-02A1-4	2.1	1	R1	#12 62 in-lbs	#12 62 in-lbs	#10 55 in-lbs	#10 55 in-lbs	#10 0.7 ft-lbs	#2 50 in-lbs	#2 50 in-lbs
ACH580-PxR-03A0-4	3	1.5	R1							
ACH580-PxR-03A5-4	3.5	2	R1							
ACH580-PxR-04A8-4	4.8	3	R1							
ACH580-PxR-07A6-4	7.6	5	R1							
ACH580-PxR-012A-4	12	7.5	R1							
ACH580-PxR-014A-4	14	10	R2	#10 62 in-lbs	#10 62 in-lbs	#8 55 in-lbs	#8 55 in-lbs	#6 1.1 ft-lbs		
ACH580-PxR-023A-4	23	15	R2	#8 62 in-lbs	#8 62 in-lbs	#6 55 in-lbs	#6 55 in-lbs	#2 2.6 ft-lbs		
ACH580-PxR-027A-4	27	20	R3			#4 55 in-lbs	#4 55 in-lbs			
ACH580-PxR-034A-4	34	25	R3			#6 62 in-lbs	#6 62 in-lbs			
ACH580-PxR-044A-4	44	30	R3	#1/0 124 in-lbs	#6 62 in-lbs	#2 55 in-lbs	#2 55 in-lbs	#1 3.0 ft-lbs		
ACH580-PxR-052A-4	52	40	R4			#2 55 in-lbs	#2 55 in-lbs			
ACH580-PxR-065A-4	65	50	R4	#1/0 124 in-lbs	#1/0 124 in-lbs	#1 55 in-lbs	#1 55 in-lbs			
ACH580-PxR-077A-4	77	60	R4	#1/0 124 in-lbs		#1/0 55 in-lbs	#1/0 55 in-lbs			
ACH580-PxR-096A-4	96	75	R5	#1/0 124 in-lbs	Consult Factory	#3/0 275 in-lbs	Consult Factory	#2/0 4.1 ft-lbs	3 x #3/0 250 in-lbs	Consult Factory
ACH580-PxR-124A-4	124	100	R6	#2/0 124 in-lbs		250 MCM 275 in-lbs		300 MCM 22.1 ft-lbs		
ACH580-PxR-156A-4	156	125	R7	#3/0 124 in-lbs		300 MCM 275 in-lbs		500 MCM 29.5 ft-lbs		
ACH580-PxR-180A-4	180	150	R7	#4/0 124 in-lbs		2 x 500 MCM 274 in-lbs		2 x 300 MCM 29.6 ft-lbs		
ACH580-PxR-240A-4	240	200	R8	350 MCM 274 in-lbs						

1) "PxR" represents both PCR and PDR.

575 Volt	Output Range		Base Drive Frame Size	Maximum Power Wiring Data						
	A	HP		Circuit Breaker UL (NEMA) Type 1 and 12	Circuit Breaker UL (NEMA) Type 3R	Disconnect Switch UL (NEMA) Type 1 and 12	Disconnect Switch UL (NEMA) Type 3R	ACH580 Motor Terminals	Ground Lugs UL (NEMA) Type 1 and 12	Ground Lugs UL (NEMA) Type 3R
ACH580-PxR-02A7-6	2.7	2	R2	#10 62 in-lbs	#10 62 in-lbs	#10 55 in-lbs	#10 55 in-lbs	#6 1.1 ft-lbs	#2 50 in-lbs	#2 50 in-lbs
ACH580-PxR-03A9-6	3.9	3	R2	#12 62 in-lbs	#12 62 in-lbs					
ACH580-PxR-06A1-6	6.1	5	R2	#10 62 in-lbs	#10 62 in-lbs					
ACH580-PxR-09A0-6	9	7.5	R2							
ACH580-PxR-011A-6	11	10	R2	#6 62 in-lbs	#6 62 in-lbs	#6 55 in-lbs	#6 55 in-lbs	#2 2.6 ft-lbs	#2 50 in-lbs	#2 50 in-lbs
ACH580-PxR-017A-6	17	15	R2							
ACH580-PxR-022A-6	22	20	R3							
ACH580-PxR-027A-6	27	25	R3	#4 62 in-lbs	#4 62 in-lbs	#4 55 in-lbs	#4 55 in-lbs	#2 2.6 ft-lbs	#2 50 in-lbs	#2 50 in-lbs
ACH580-PxR-032A-6	32	30	R3							
ACH580-PxR-041A-6	41	40	R5	#3 62 in-lbs	Consult Factory	#3 55 in-lbs	#2 55 in-lbs	#2/0 4.1 ft-lbs	3 x #3/0 250 in-lbs	Consult Factory
ACH580-PxR-052A-6 ³	52	50	R5	#2 62 in-lbs						
ACH580-PxR-062A-6	62	60	R6	#1 62 in-lbs						
ACH580-PxR-077A-6	77	75	R6	#1/0 62 in-lbs						
ACH580-PxR-099A-6	99	100	R7	#3/0 124 in-lbs						
ACH580-PxR-125A-6	125	125	R7	250 MCM 124 in-lbs						
ACH580-PxR-144A-6	144	150	R8							

1) "PxR" represents both PCR and PDR.

2) PCR is rated 600Y/347V unless otherwise specified. For use on a solidly grounded Wye source only.

3) PCR supports Delta network configuration.

Branch circuit protection

Input power is connected to the ACH580 with E-Clipse Bypass through a door interlocked disconnect switch or circuit breaker. Neither of these inputs are fused. The branch circuit that provides power to the ACH580 with E-Clipse Bypass with disconnect switch must include the specified external fuses to provide short circuit and ground fault protection for the motor in the bypass mode.

When connected to a 240V or 480V power source, the ACH580 with E-Clipse Bypass with the circuit breaker option is suitable for use on a circuit capable of delivering not more than 100,000 RMS symmetrical amperes. When connected to a 600V power source, PCR configurations are suitable for use on a circuit capable of delivering not more than 10,000 RMS symmetrical amperes (75-150 HP), and not more than 25,000 RMS symmetrical amperes (2-60 HP).

Fuses

Note: The UL listed drive fuses in the table are provided in the purchased product.

- Replacement fuses are required to be of the same class, current rating, and voltage rating. Fuses from other manufacturers can be used if they are 600V rated and meet the specifications given in the table.
- Fuses with higher current rating than specified must not be used.

208 Volt fuses for packaged drive

208 Volt Type Code ¹	Nominal Output Range		Base Drive Frame Size	Internal Drive Fuse Rating		External Fuse for Disconnect Option	
	Drive Current	Package Power		Class	Current Rating	Class	Max Current Rating
	A	HP					
ACH580-PxR-04A6-2	4.6	1	R1	Class CC	15A	N/A	N/A
ACH580-PxR-06A6-2	6.6	1.5	R1	Class CC	15A	N/A	N/A
ACH580-PxR-07A5-2	7.5	2	R1	Class CC	15A	N/A	N/A
ACH580-PxR-10A6-2	10.6	3	R1	Class CC	15A	N/A	N/A
ACH580-PxR-017A-2	16.7	5	R1	Class CC	30A	N/A	N/A
ACH580-PxR-024A-2	24.2	7.5	R2	Class CC	30A	N/A	N/A
ACH580-PxR-031A-2	30.8	10	R2	Class T	40A	N/A	N/A
ACH580-PxR-046A-2	46.2	15	R3	Class T	80A	N/A	N/A
ACH580-PxR-059A-2	59.4	20	R3	Class T	80A	N/A	N/A
ACH580-PxR-075A-2	74.8	25	R4	Class T	100A	N/A	N/A
ACH580-PxR-088A-2	88	30	R5	Class T	110A	N/A	N/A
ACH580-PxR-114A-2	114	40	R5	Class T	150A	N/A	N/A
ACH580-PxR-144A-2	143	50	R6	Class T	200A	N/A	N/A
ACH580-PxR-169A-2	169	60	R7	Class T	250A	N/A	N/A
ACH580-PxR-211A-2	211	75	R7	Class T	300A	Class J or RK1	400A
ACH580-PxR-248A-2	248	100 ²	R8	Class T	350A	Class J or RK1	400A

1) "PxR" represents both PCR and PDR.

2) 100 HP @ 230V

460 Volt fuses for packaged drive

480 Volt	Nominal Output Range		Base Drive Frame Size	Internal Drive Fuse Rating		External Fuse for Disconnect Option	
	Drive Current	Package Power		Class	Current Rating	Class	Max Current Rating
	A	HP					
ACH580-PxR-02A1-4	2.1	1	R1	Class CC	15A	N/A	N/A
ACH580-PxR-03A0-4	3	1.5	R1	Class CC	15A	N/A	N/A
ACH580-PxR-03A5-4	3.5	2	R1	Class CC	15A	N/A	N/A
ACH580-PxR-04A8-4	4.8	3	R1	Class CC	15A	N/A	N/A
ACH580-PxR-07A6-4	7.6	5	R1	Class CC	15A	N/A	N/A
ACH580-PxR-012A-4	12	7.5	R1	Class CC	15A	N/A	N/A
ACH580-PxR-014A-4	14	10	R2	Class CC	30A	N/A	N/A
ACH580-PxR-023A-4	23	15	R2	Class CC	30A	N/A	N/A
ACH580-PxR-027A-4	27	20	R3	Class T	40A	N/A	N/A
ACH580-PxR-034A-4	34	25	R3	Class T	60A	N/A	N/A
ACH580-PxR-044A-4	44	30	R3	Class T	60A	N/A	N/A
ACH580-PxR-052A-4	52	40	R4	Class T	80A	N/A	N/A
ACH580-PxR-065A-4	65	50	R4	Class T	90A	N/A	N/A
ACH580-PxR-077A-4	77	60	R4	Class T	100A	N/A	N/A
ACH580-PxR-096A-4	96	75	R5	Class T	150A	N/A	N/A
ACH580-PxR-124A-4	124	100	R6	Class T	200A	N/A	N/A
ACH580-PxR-156A-4	156	125	R7	Class T	225A	N/A	N/A
ACH580-PxR-180A-4	180	150	R7	Class T	300A	N/A	N/A
ACH580-PxR-240A-4	240	200	R8	Class T	350A	Class J or RK1	400A Max

1) "PxR" represents both PCR and PDR.

575 Volt fuses for packaged drive

575 Volt	Nominal Output Range		Base Drive Frame Size	Internal Drive Fuse Rating		External Fuse for Disconnect Option	
	Drive Current	Package Power		Class	Current Rating	Class	Max Current Rating
	A	HP					
ACH580-PxR-02A7-6	2.7	2	R2	Class CC	15A	N/A	N/A
ACH580-PxR-03A9-6	3.9	3	R2	Class CC	15A	N/A	N/A
ACH580-PxR-06A1-6	3.5	6.1	R2	Class CC	15A	N/A	N/A
ACH580-PxR-09A0-6	4.8	9	R2	Class CC	15A	N/A	N/A
ACH580-PxR-011A-6	7.6	11	R2	Class CC	30A	N/A	N/A
ACH580-PxR-017A-6	17	15	R2	Class CC	30A	N/A	N/A
ACH580-PxR-022A-6	22	20	R3	Class T	40A	N/A	N/A
ACH580-PxR-027A-6	27	25	R3	Class T	40A	N/A	N/A
ACH580-PxR-032A-6	32	30	R3	Class T	40A	N/A	N/A
ACH580-PxR-041A-6	41	40	R5	Class T	50A	N/A	N/A

575 Volt	Nominal Output Range		Base Drive Frame Size	Internal Drive Fuse Rating		External Fuse for Disconnect Option	
	Drive Current	Package Power		Class	Current Rating	Class	Max Current Rating
	A	HP					
ACH580-PxR-052A-6 ³	52	50	R5	Class T	80A	N/A	N/A
ACH580-PxR-062A-6	62	60	R5	Class T	80A	N/A	N/A
ACH580-PxR-077A-6	77	75	R5	Class T	100A	N/A	N/A
ACH580-PxR-099A-6	99	100	R7	Class T	150A	N/A	N/A
ACH580-PxR-125A-6	125	125	R7	Class T	175A	N/A	N/A
ACH580-PxR-144A-6	144	150	R8	Class T	200A	N/A	N/A
ACH580-PxR-180A-4	180	150	R2	Class T	300A	N/A	N/A
ACH580-PxR-240A-4	240	200	R2	Class T	350A	Class J or RK1	400A Max

1) "PxR" represents both PCR and PDR.

2) PCR is rated 600Y/347V unless otherwise specified. For use on a solidly grounded Wye source only.

3) PCR supports Delta network configuration.

Operation

This information is unique to ACH580 input disconnect configurations (PCR or PDR). Refer to the [Operation](#) instructions on page 45 for all other information.

Input disconnect configuration

The ACH580 with Input Disconnect is an ACH580 AC adjustable frequency drive packaged with an input disconnect switch or circuit breaker, and with a door interlocked, external operating handle. The operating handle can be padlocked in the OFF position (padlock not supplied). Enclosure options are UL (NEMA) Type 1, UL (NEMA) Type 12, and UL (NEMA) Type 3R (NEMA 1, NEMA 12, and NEMA 3R).

The following is a typical power diagram.

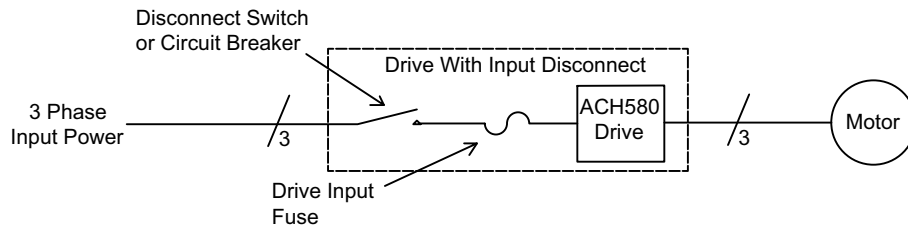

The following shows the front view of the ACH580 Vertical Packaged Drive configuration and identifies the major components.

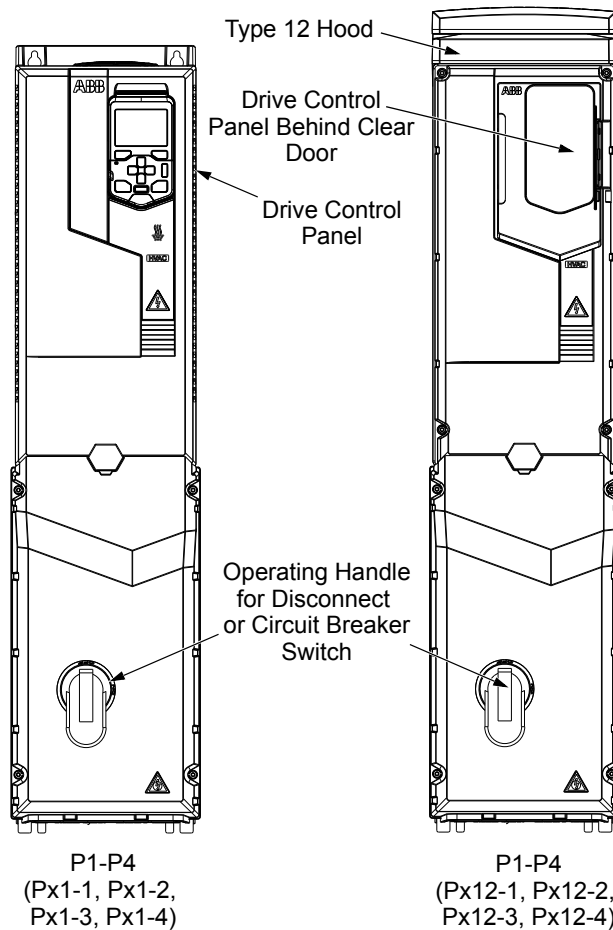

The following shows the front view of the ACH580 Box Packaged Drive configurations and identifies the major components.

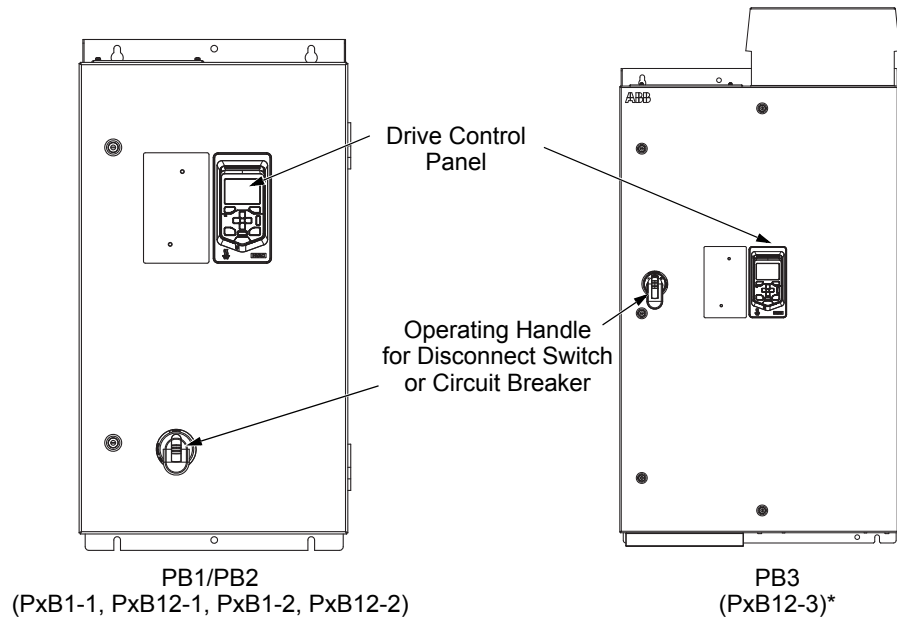

*Hood and filter kit not shown

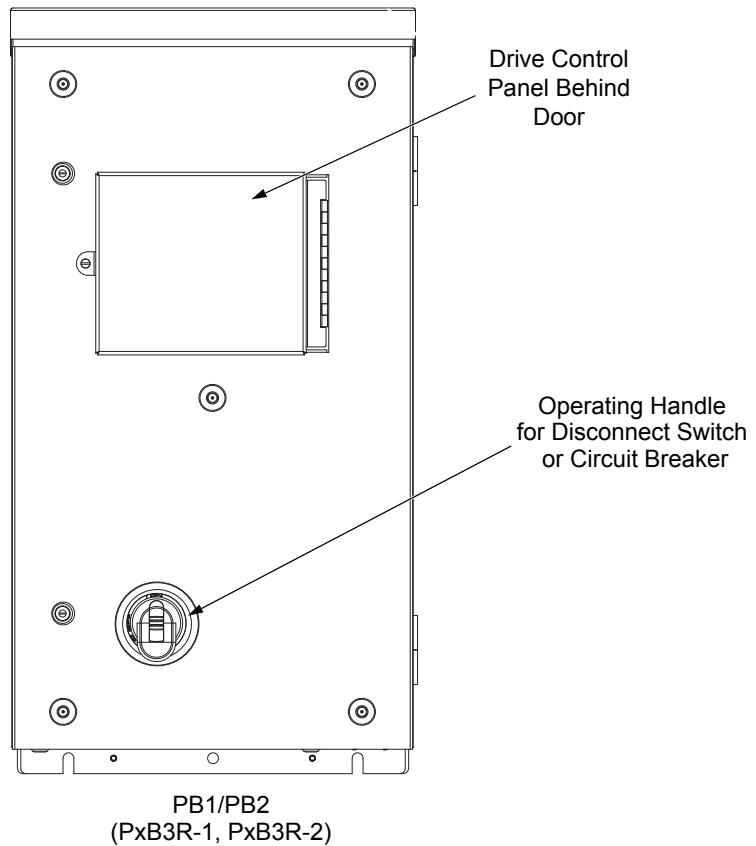

Maintenance

Maintenance intervals

If installed in an appropriate environment, the drive requires very little maintenance. This table lists the routine maintenance intervals recommended by ABB for ACH580 enclosures in addition to the intervals on page 81.

Maintenance	Configuration	Interval	Instruction
Check/replace hinged door wall mount enclosure inlet air filter	Hinged door wall mount UL (NEMA) Type 12 enclosures	Check every 3 months. Replace as needed.	Enclosure air filter replacement B3 – UL (NEMA) Type 12 hinged door wall mount enclosures on page 150.

Enclosure air filter replacement B3 – UL (NEMA) Type 12 hinged door wall mount enclosures

Filter material

Material	Filter Type
American Air Filter (358-35-06A-12A)	POLYKLEON WHITE 12.7mm (1/2 in.) X 152.4mm (6 in.) X 304.6mm (12 in.) stk.

This procedure applies to drive with input disconnect configurations in UL (NEMA) Type 12 hinged door wall mount enclosures. This filter is located at the bottom of the enclosure. Use the following procedure to check and replace filters.

1. On the enclosure, remove the screws holding the filter bracket in place.
2. Remove the filter kit from the enclosure.

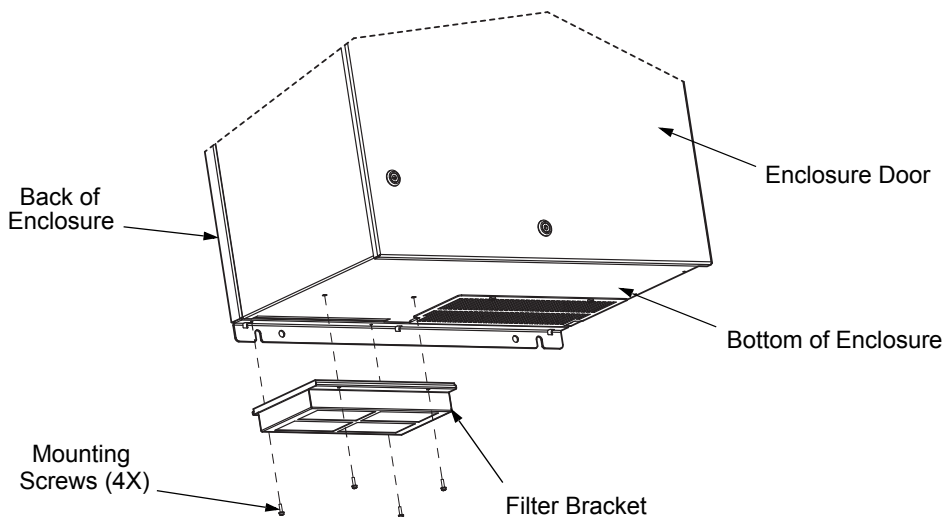

3. Lift the filter out of the filter bracket and replace as appropriate.
4. With the filter in the filter bracket, reinstall filter kit onto enclosure.
5. Replace the mounting screws. Tighten to the recommended torque of 2 N•m (1.47 ft-lbs) per installation instruction 3AXD50000221370.

Diagnostics

Refer to the [Diagnostics](#) instructions on page 57.

GROUP 25			
Speed control			
25.01 Torque reference speed control	31.20 Earth fault	34.38 Timer 10 configuration	36.45 AL2 50 to 60%
25.02 Speed proportional gain	31.21 Supply phase loss	34.39 Timer 10 start time	36.46 AL2 60 to 70%
25.03 Speed integration time	31.22 STO indication run/stop	34.40 Timer 10 duration	36.47 AL2 70 to 80%
25.04 Speed derivation time	31.23 Wiring or earth fault	34.41 Timer 11 configuration	36.48 AL2 80 to 90%
25.05 Derivation filter time	31.24 Stall function	34.42 Timer 11 start time	36.49 AL2 over 90%
25.06 Acc comp derivation time	31.25 Stall current limit	34.43 Timer 11 duration	36.50 AL2 reset date
25.07 Acc comp filter time	31.26 Stall speed limit	34.44 Timer 12 configuration	36.51 AL2 reset time
25.15 Proportional gain em stop	31.27 Stall frequency limit	34.45 Timer 12 start time	
25.53 Torque prop reference	31.28 Stall time	34.46 Timer 12 duration	GROUP 37
25.54 Torque integral reference	31.30 Overspeed trip margin	34.60 Season 1 start date	User load curve
25.55 Torque deriv reference	31.32 Emergency ramp supervision	34.61 Season 2 start date	37.01 ULC output status word
25.56 Torque acc compensation	31.33 Emergency ramp supervision delay	34.62 Season 3 start date	37.02 ULC supervision signal
		34.63 Season 4 start date	37.03 ULC overload actions
		34.70 Number of active exceptions	37.04 ULC underload actions
		34.71 Exception types	37.11 ULC speed table point 1
GROUP 28	31.36 Aux fan fault bypass	34.72 Exception 1 start	37.12 ULC speed table point 2
Frequency reference chain	GROUP 32	34.73 Exception 1 length	37.13 ULC speed table point 3
28.01 Frequency ref ramp input	Supervision	34.74 Exception 2 start	37.14 ULC speed table point 4
28.02 Frequency ref ramp output	32.01 Supervision status	34.75 Exception 2 length	37.15 ULC speed table point 5
28.11 Ext1 frequency ref1	32.05 Supervision 1 function	34.76 Exception 3 start	37.16 ULC frequency table point 1
28.12 Ext1 frequency ref2	32.06 Supervision 1 action	34.77 Exception 3 length	37.17 ULC frequency table point 2
28.13 Ext1 frequency function	32.07 Supervision 1 signal	34.78 Exception day 4	37.18 ULC frequency table point 3
28.15 Ext2 frequency ref1	32.08 Supervision 1 filter time	34.79 Exception day 5	37.19 ULC frequency table point 4
28.16 Ext2 frequency ref2	32.09 Supervision 1 low	34.80 Exception day 6	37.20 ULC frequency table point 5
28.17 Ext2 frequency function	32.10 Supervision 1 high	34.81 Exception day 7	37.21 ULC underload point 1
28.21 Constant frequency function	32.11 Supervision 1 hysteresis	34.82 Exception day 8	37.22 ULC underload point 2
28.22 Constant frequency sel1	32.15 Supervision 2 function	34.83 Exception day 9	37.23 ULC underload point 3
28.23 Constant frequency sel2	32.16 Supervision 2 action	34.84 Exception day 10	37.24 ULC underload point 4
28.24 Constant frequency sel3	32.17 Supervision 2 signal	34.85 Exception day 11	37.25 ULC underload point 5
28.26 Constant frequency 1	32.18 Supervision 2 filter time	34.86 Exception day 12	37.31 ULC overload point 1
28.27 Constant frequency 2	32.19 Supervision 2 low	34.87 Exception day 13	37.32 ULC overload point 2
28.28 Constant frequency 3	32.20 Supervision 2 high	34.88 Exception day 14	37.33 ULC overload point 3
28.29 Constant frequency 4	32.21 Supervision 2 hysteresis	34.89 Exception day 15	37.34 ULC overload point 4
28.30 Constant frequency 5	32.25 Supervision 3 function	34.90 Exception day 16	37.35 ULC overload point 5
28.31 Constant frequency 6	32.26 Supervision 3 action	34.100 Timed function 1	37.41 ULC overload timer
28.32 Constant frequency 7	32.27 Supervision 3 signal	34.101 Timed function 2	37.42 ULC underload timer
28.41 Frequency ref safe	32.28 Supervision 3 filter time	34.102 Timed function 3	
28.51 Critical frequency function	32.29 Supervision 3 low	34.110 Boost time function	GROUP 40
28.52 Critical frequency 1 low	32.30 Supervision 3 high	34.111 Boost time activation source	Process PID set 1
28.53 Critical frequency 1 high	32.31 Supervision 3 hysteresis	34.111 Boost time duration	40.01 Process PID output actual
28.54 Critical frequency 2 low	32.35 Supervision 4 function		40.02 Process PID feedback actual
28.55 Critical frequency 2 high	32.36 Supervision 4 action		40.03 Process PID setpoint actual
28.56 Critical frequency 3 low	32.37 Supervision 4 signal	GROUP 35	40.04 Process PID deviation actual
28.57 Critical frequency 3 high	32.38 Supervision 4 filter time	Motor thermal protection	40.06 Process PID status word
28.71 Freq ramp set selection	32.39 Supervision 4 low	35.01 Motor estimated temperature	40.07 Process PID operation mode
28.72 Freq acceleration time 1	32.40 Supervision 4 high	35.02 Measured temperature 1	40.08 Set 1 feedback 1 source
28.73 Freq deceleration time 1	32.41 Supervision 4 hysteresis	35.03 Measured temperature 2	40.09 Set 1 feedback 2 source
28.74 Freq acceleration time 2	32.45 Supervision 5 function	35.11 Temperature 1 source	40.10 Set 1 feedback function
28.75 Freq deceleration time 2	32.46 Supervision 5 action	35.12 Temperature 1 fault limit	40.11 Set 1 feedback filter time
28.76 Freq ramp in zero source	32.47 Supervision 5 signal	35.13 Temperature 1 warning limit	40.14 Set 1 setpoint scaling
28.92 Frequency ref act 3	32.48 Supervision 5 filter time	35.14 Temperature 1 AI source	40.15 Set 1 output scaling
28.96 Frequency ref act 7	32.49 Supervision 5 low	35.22 Temperature 2 fault limit	40.16 Set 1 setpoint 1 source
28.97 Frequency ref unlimited	32.50 Supervision 5 high	35.23 Temperature 2 warning limit	40.17 Set 1 setpoint 2 source
	32.51 Supervision 5 hysteresis	35.24 Temperature 2 AI source	40.18 Set 1 setpoint function
	32.55 Supervision 6 function	35.31 Safe motor temperature enable	40.19 Set 1 internal setpoint sel1
	32.56 Supervision 6 action	35.50 Motor ambient temperature	40.20 Set 1 internal setpoint sel2
	32.57 Supervision 6 signal	35.51 Motor load curve	40.21 Set 1 internal setpoint 1
	32.58 Supervision 6 filter time	35.52 Zero speed load	40.22 Set 1 internal setpoint 2
	32.59 Supervision 6 low	35.53 Break point	40.23 Set 1 internal setpoint 3
	32.60 Supervision 6 high	35.54 Motor nominal temperature rise	40.24 Set 1 internal setpoint 0
	32.61 Supervision 6 hysteresis	35.55 Motor thermal time constant	40.26 Set 1 setpoint min
			40.27 Set 1 setpoint max
			40.28 Set 1 setpoint increase time
			40.29 Set 1 setpoint decrease time
			40.30 Set 1 setpoint freeze enable
			40.31 Set 1 deviation inversion
			40.32 Set 1 gain
			40.33 Set 1 integration time
			40.34 Set 1 derivation time
			40.35 Set 1 derivation filter time
			40.36 Set 1 output min
			40.37 Set 1 output max
			40.38 Set 1 output freeze enable
			40.39 Set 1 deadband range
			40.40 Set 1 deadband delay
			40.43 Set 1 sleep level
			40.44 Set 1 sleep delay
			40.45 Set 1 sleep boost time
			40.46 Set 1 sleep boost step
			40.47 Set 1 wake-up deviation
			40.48 Set 1 wake-up delay
			40.49 Set 1 tracking mode
			40.50 Set 1 tracking ref selection
			40.57 PID set1/set2 selection
			40.58 Set 1 increase prevention
			40.59 Set 1 decrease prevention
			40.60 Set 1 PID activation source
			40.61 Setpoint scaling actual
			40.62 PID internal setpoint actual
			40.70 Compensated setpoint
			40.71 Set 1 compensation input source
			40.72 Set 1 compensation input 1

40.73	Set 1 compensated output 1
40.74	Set 1 compensation input 2
40.75	Set 1 compensated output 2
40.76	Set 1 compensation non-linearity
40.80	Set 1 PID output min source
40.81	Set 1 PID output max source
40.89	Set 1 setpoint multiplier
40.90	Set 1 feedback multiplier
40.91	Feedback data storage
40.92	Setpoint data storage
40.96	Process PID output %
40.97	Process PID feedback %
40.98	Process PID setpoint %
40.99	Process PID deviation %
GROUP 41	
Process PID set 2	
41.08	Set 2 feedback 1 source
41.09	Set 2 feedback 2 source
41.10	Set 2 feedback function
41.11	Set 2 feedback filter time
41.14	Set 2 setpoint scaling
41.15	Set 2 output scaling
41.16	Set 2 setpoint 1 source
41.17	Set 2 setpoint 2 source
41.18	Set 2 setpoint function
41.19	Set 2 internal setpoint sel1
41.20	Set 2 internal setpoint sel2
41.21	Set 2 internal setpoint 1
41.22	Set 2 internal setpoint 2
41.23	Set 2 internal setpoint 3
41.24	Set 2 internal setpoint 0
41.26	Set 2 setpoint min
41.27	Set 2 setpoint max
41.28	Set 2 setpoint increase time
41.29	Set 2 setpoint decrease time
41.30	Set 2 setpoint freeze enable
41.31	Set 2 deviation inversion
41.32	Set 2 gain
41.33	Set 2 integration time
41.34	Set 2 derivation time
41.35	Set 2 derivation filter time
41.36	Set 2 output min
41.37	Set 2 output max
41.38	Set 2 output freeze enable
41.39	Set 2 deadband range
41.40	Set 2 deadband delay
41.43	Set 2 sleep level
41.44	Set 2 sleep delay
41.45	Set 2 sleep boost time
41.46	Set 2 sleep boost step
41.47	Set 2 wake-up deviation
41.48	Set 2 wake-up delay
41.49	Set 2 tracking mode
41.50	Set 2 tracking ref selection
41.58	Set 2 increase prevention
41.59	Set 2 decrease prevention
41.60	Set 2 PID activation source
41.71	Set 2 compensation input source
41.72	Set 2 compensation input 1
41.73	Set 2 compensated output 1
41.74	Set 2 compensation input 2
41.75	Set 2 compensated output 2
41.76	Set 2 compensation non-linearity
41.80	Set 2 PID output min source
41.81	Set 2 PID output max source
41.89	Set 2 setpoint multiplier
41.90	Set 2 feedback multiplier
GROUP 43	
Brake chopper	
43.01	Braking resistor temperature
43.06	Brake chopper function
43.07	Brake chopper run permissive
43.08	Brake resistor thermal tc
43.09	Brake resistor Pmax cont
43.10	Brake resistance
43.11	Brake resistor fault limit
43.12	Brake resistor warning limit
GROUP 45	
Energy efficiency	
45.01	Saved GW hours
45.02	Saved MW hours
45.03	Saved kW hours
45.04	Saved energy
45.05	Saved money x1000
45.06	Saved money
45.07	Saved amount
45.08	CO2 reduction in kilotons
45.09	CO2 reduction in tons
45.10	Total saved CO2
45.11	Energy optimizer
45.12	Energy tariff 1
45.13	Energy tariff 2
45.14	Tariff selection
45.18	CO2 conversion factor
45.19	Comparison power
45.21	Energy calculations reset
45.24	Hourly peak power value
45.25	Hourly peak power time
45.26	Hourly total energy (resettable)
45.27	Daily peak power value (resettable)
45.28	Daily peak power time
45.29	Daily total energy (resettable)
45.30	Last day total energy
45.31	Monthly peak power value (resettable)
45.32	Monthly peak power date
45.33	Monthly peak power time
45.34	Monthly total energy (resettable)
45.35	Last month total energy
45.36	Lifetime peak power value
45.37	Lifetime peak power date
45.38	Lifetime peak power time
GROUP 46	
Monitoring/scaling settings	
46.01	Speed scaling
46.02	Frequency scaling
46.03	Torque scaling
46.04	Power scaling
46.05	Current scaling
46.06	Speed ref zero scaling
46.11	Filter time motor speed
46.12	Filter time output frequency
46.13	Filter time motor torque
46.14	Filter time power
46.21	At speed hysteresis
46.22	At frequency hysteresis
46.31	Above speed limit
46.32	Above frequency limit
46.41	kWh pulse scaling
GROUP 47	
Data storage	
47.01	Data storage 1 real32
47.02	Data storage 2 real32
47.03	Data storage 3 real32
47.04	Data storage 4 real32
47.11	Data storage 1 int32
47.12	Data storage 2 int32
47.13	Data storage 3 int32
47.14	Data storage 4 int32
47.21	Data storage 1 int16
47.22	Data storage 2 int16
47.23	Data storage 3 int16
47.24	Data storage 4 int16
GROUP 49	
Panel port communication	
49.01	Node ID number
49.03	Baud rate
49.04	Communication loss time
49.05	Communication loss action
49.06	Refresh settings
GROUP 50	
Fieldbus adapter (FBA)	
50.01	FBA A enable
50.02	FBA A comm loss func
50.03	FBA A comm loss t out
50.04	FBA A ref1 type
50.05	FBA A ref2 type
50.06	FBA A SW sel
50.07	FBA A actual 1 type
50.08	FBA A actual 2 type
50.09	FBA A SW transparent source
50.10	FBA A act1 transparent source
50.11	FBA A act2 transparent source
50.12	FBA A debug mode
50.13	FBA A control word
50.14	FBA A reference 1
50.15	FBA A reference 2
50.16	FBA A status word
50.17	FBA A actual value 1
50.18	FBA A actual value 2
GROUP 51	
FBA A settings	
51.01	FBA A type
51.02	FBA A Par2
51.03	FBA A Par3
51.04	FBA A Par4
51.05	FBA A Par5
51.06	FBA A Par6
51.07	FBA A Par7
51.08	FBA A Par8
51.09	FBA A Par9
51.10	FBA A Par10
51.11	FBA A Par11
51.12	FBA A Par12
51.13	FBA A Par13
51.14	FBA A Par14
51.15	FBA A Par15
51.16	FBA A Par16
51.17	FBA A Par17
51.18	FBA A Par18
51.19	FBA A Par19
51.20	FBA A Par20
51.21	FBA A Par21
51.22	FBA A Par22
51.23	FBA A Par23
51.24	FBA A Par24
51.25	FBA A Par25
51.26	FBA A Par26
51.27	FBA A par refresh
51.28	FBA A par table ver
51.29	FBA A drive type code
51.30	FBA A mapping file ver
51.31	D2FBA A comm status
51.32	FBA A comm SW ver
51.33	FBA A appl SW ver
GROUP 52	
FBA A data in	
52.01	FBA A data in1
52.02	FBA A data in2
52.03	FBA A data in3
52.04	FBA A data in4
52.05	FBA A data in5
52.06	FBA A data in6
52.07	FBA A data in7
52.08	FBA A data in8
52.09	FBA A data in9
52.10	FBA A data in10
52.11	FBA A data in11
52.12	FBA A data in12
GROUP 53	
FBA A data out	
53.01	FBA data out1
53.02	FBA data out2
53.03	FBA data out3
53.04	FBA data out4
53.05	FBA data out5
53.06	FBA data out6
53.07	FBA data out7
53.08	FBA data out8
53.09	FBA data out9
53.10	FBA data out10
53.11	FBA data out11
53.12	FBA data out12
GROUP 58	
Embedded fieldbus	
58.01	Protocol enable
58.02	Protocol ID
58.03	Node address
58.04	Baud rate
58.05	Parity
58.06	Communication control
58.07	Communication diagnostics
58.08	Received packets
58.09	Transmitted packets
58.10	All packets
58.11	UART errors
58.12	CRC errors
58.13	Token counter
58.14	Communication loss action
58.15	Communication loss mode
58.16	Communication loss time
58.17	Transmit delay
58.18	EFB control word
58.19	EFB status word
58.21	Device network usage
58.22	Token loop time
58.25	Control profile
58.26	EFB ref1 type
58.27	EFB ref2 type
58.28	EFB act1 type
58.29	EFB act2 type
58.30	EFB status word transparent source
58.31	EFB act1 transparent source
58.32	EFB act2 transparent source
58.33	Addressing mode
58.34	Word order
58.35	Return app error
58.40	Device object ID
58.41	Max master
58.42	Max info frames
58.43	Max APDU retries
58.44	APDU timeout
58.101	Data I/O 1
58.102	Data I/O 2
58.103	Data I/O 3
58.104	Data I/O 4
58.105	Data I/O 5
58.106	Data I/O 6
58.107	Data I/O 7
58.108	Data I/O 8
58.109	Data I/O 9
58.110	Data I/O 10
58.111	Data I/O 11
58.112	Data I/O 12
58.113	Data I/O 13
58.114	Data I/O 14
GROUP 70	
Override	
70.01	Override status
70.02	Override enable
70.03	Override activation source
70.04	Override reference source
70.05	Override direction
70.06	Override frequency
70.07	Override speed
70.10	Override enables selection
70.20	Override fault handling
70.21	Override auto reset trials
70.22	Override auto reset time
70.40	Override Log 1 Start Date
70.41	Override Log 1 Start Time
70.42	Override Log 1 End Date
70.43	Override Log 1 End Time
70.44	Override Log 1 Fault 1
70.45	Override Log 1 Fault 2
70.46	Override Log 1 Fault 3
70.47	Override Log 1 Warning 1
70.48	Override Log 1 Warning 2
70.49	Override Log 1 Warning 3
70.50	Override Log 2 Start Date
70.51	Override Log 2 Start Time
70.52	Override Log 2 End Date
70.53	Override Log 2 End Time
70.54	Override Log 2 Fault 1
70.55	Override Log 2 Fault 2
70.56	Override Log 2 Fault 3
70.57	Override Log 2 Warning 1
70.58	Override Log 2 Warning 2
70.59	Override Log 2 Warning 3
70.60	Override Log 3 Start Date
70.61	Override Log 3 Start Time
70.62	Override Log 3 End Date
70.63	Override Log 3 End Time
70.64	Override Log 3 Fault 1
70.65	Override Log 3 Fault 2
70.66	Override Log 3 Fault 3
70.67	Override Log 3 Warning 1
70.68	Override Log 3 Warning 2
70.69	Override Log 3 Warning 3
GROUP 71	
External PID1	
71.01	External PID act value
71.02	Feedback act value
71.03	Setpoint act value
71.04	Deviation act value
71.06	PID status word
71.07	PID operation mode
71.08	Feedback 1 source
71.11	Feedback filter time
71.14	Setpoint scaling
71.15	Output scaling
71.16	Setpoint 1 source
71.19	Internal setpoint sel1
71.20	Internal setpoint sel2
71.21	Internal setpoint 1
71.22	Internal setpoint 2
71.23	Internal setpoint 3
71.26	Setpoint min
71.27	Setpoint max
71.31	Deviation inversion
71.32	Gain
71.33	Integration time

71.34	Derivation time
71.35	Derivation filter time
71.36	Output min
71.37	Output max
71.38	Output freeze enable
71.39	Deadband range
71.40	Deadband delay
71.58	Increase prevention
71.59	Decrease prevention
71.62	Internal setpoint actual
GROUP 72	
External PID2	
72.01	External PID act value
72.02	Feedback act value
72.03	Setpoint act value
72.04	Deviation act value
72.06	PID status word
72.07	PID operation mode
72.08	Feedback 1 source
72.11	Feedback filter time
72.14	Setpoint scaling
72.15	Output scaling
72.16	Setpoint 1 source
72.19	Internal setpoint sel1
72.20	Internal setpoint sel2
72.21	Internal setpoint 1
72.22	Internal setpoint 2
72.23	Internal setpoint 3
72.26	Setpoint min
72.27	Setpoint max
72.31	Deviation inversion
72.32	Gain
72.33	Integration time
72.34	Derivation time
72.35	Derivation filter time
72.36	Output min
72.37	Output max
72.38	Output freeze enable
72.39	Deadband range
72.40	Deadband delay
72.58	Increase prevention
72.59	Decrease prevention
72.62	Internal setpoint actual
GROUP 73	
External PID3	
73.01	External PID act value
73.02	Feedback act value
73.03	Setpoint act value
73.04	Deviation act value
73.06	PID status word
73.07	PID operation mode
73.08	Feedback 1 source
73.11	Feedback filter time
73.14	Setpoint scaling
73.15	Output scaling
73.16	Setpoint 1 source
73.19	Internal setpoint sel1
73.20	Internal setpoint sel2
73.21	Internal setpoint 1
73.22	Internal setpoint 2
73.23	Internal setpoint 3
73.26	Setpoint min
73.27	Setpoint max
73.31	Deviation inversion
73.32	Gain
73.33	Integration time
73.34	Derivation time
73.35	Derivation filter time
73.36	Output min
73.37	Output max
73.38	Output freeze enable
73.39	Deadband range
73.40	Deadband delay
73.58	Increase prevention
73.59	Decrease prevention
73.62	Internal setpoint actual
GROUP 74	
External PID4	
74.01	External PID act value
74.02	Feedback act value
74.03	Setpoint act value
74.04	Deviation act value
74.06	PID status word
74.07	PID operation mode
74.08	Feedback 1 source
74.11	Feedback filter time
74.14	Setpoint scaling
74.15	Output scaling
74.16	Setpoint 1 source
74.19	Internal setpoint sel1
74.20	Internal setpoint sel2
74.21	Internal setpoint 1

74.22	Internal setpoint 2
74.23	Internal setpoint 3
74.26	Setpoint min
74.27	Setpoint max
74.31	Deviation inversion
74.32	Gain
74.33	Integration time
74.34	Derivation time
74.35	Derivation filter time
74.36	Output min
74.37	Output max
74.38	Output freeze enable
74.39	Deadband range
74.40	Deadband delay
74.58	Increase prevention
74.59	Decrease prevention
74.62	Internal setpoint actual
GROUP 76	
PFC configuration	
76.01	PFC status
76.02	Multipump system status
76.11	Pump/fan status 1
76.12	Pump/fan status 2
76.13	Pump/fan status 3
76.14	Pump/fan status 4
76.21	Multipump configuration
76.25	Number of motors
76.26	Min number of motors allowed
76.27	Max number of motors allowed
76.30	Start point 1
76.31	Start point 2
76.32	Start point 3
76.41	Stop point 1
76.42	Stop point 2
76.43	Stop point 3
76.55	Start delay
76.56	Stop delay
76.57	PFC speed hold on
76.58	PFC speed hold off
76.59	PFC contactor delay
76.60	PFC ramp acceleration time
76.61	PFC ramp deceleration time
76.70	Autochange
76.71	Autochange interval
76.72	Maximum wear imbalance
76.73	Autochange level
76.74	Autochange auxiliary PFC
76.81	PFC 1 interlock
76.82	PFC 2 interlock
76.83	PFC 3 interlock
76.84	PFC 4 interlock
76.95	Regulator bypass control
GROUP 77	
PFC maintenance and monitoring	
77.10	PFC runtime change
77.11	Pump/fan 1 running time
77.12	Pump/fan 2 running time
77.13	Pump/fan 3 running time
77.14	Pump/fan 4 running time
GROUP 80	
Flow calculation	
80.01	Actual flow
80.02	Actual flow percentage
80.11	Flow feedback 1 source
80.12	Flow feedback 2 source
80.13	Flow feedback function
80.14	Flow feedback multiplier
80.15	Maximum flow
80.16	Motor cos ϕ
GROUP 95	
HW configuration	
95.01	Supply voltage
95.02	Adaptive voltage limits
95.03	Estimated AC supply voltage
95.04	Control board supply
95.15	Special HW settings
95.20	HW options word 1
95.21	HW options word 2
GROUP 96	
System	
96.01	Language
96.02	Pass code
96.03	Access level status
96.04	Macro select
96.05	Macro active
96.06	Parameter restore
96.07	Parameter save manually
96.08	Control board boot
96.10	User set status

96.11	User set save/load
96.12	User set I/O mode in1
96.13	User set I/O mode in2
96.16	Unit selection
96.20	Time sync primary source
96.51	Clear fault and event logger
96.70	Disable adaptive program
GROUP 97	
Motor control	
97.01	Switching frequency reference
97.02	Minimum switching frequency
97.03	Slip gain
97.04	Voltage reserve
97.05	Flux braking
97.08	Optimizer minimum torque
97.09	Switching frequency mode
97.10	Signal injection
97.11	TR tuning
97.13	IR compensation
97.15	Motor model temperature adaptation
97.16	Stator temperature factor
97.17	Rotor temperature factor
97.20	U/F Ratio
GROUP 98	
User motor parameters	
98.01	User motor model mode
98.02	Rs user
98.03	Rr user
98.04	Lm user
98.05	SigmaL user
98.06	Ld user
98.07	Lq user
98.08	PM flux user
98.09	Rs user SI
98.10	Rr user SI
98.11	Lm user SI
98.12	SigmaL user SI
98.13	Ld user SI
98.14	Lq user SI
GROUP 99	
Motor data	
99.03	Motor type
99.04	Motor control mode
99.06	Motor nominal current
99.07	Motor nominal voltage
99.08	Motor nominal frequency
99.09	Motor nominal speed
99.10	Motor nominal power
99.11	Motor nominal cos ϕ
99.12	Motor nominal torque
99.13	ID run requested
99.14	Last ID run performed
99.15	Motor polepairs calculated
99.16	Motor phase order

For E-Clipse Bypass

GROUP 01

ACTUAL DATA

01.01 MOTOR CURR
01.02 INPUT VOLT
01.03 DI STATUS
01.04 RO STATUS
01.05 PCB TEMP
01.06 KW HOURS
01.07 COMM RO
01.08 RUN TIME
01.09 ON TIME 1
01.10 ON TIME 2
01.11 A-B VOLT
01.12 B-C VOLT
01.13 C-A VOLT
01.14 MWH SAVED
01.15 COST SAVED
01.16 CO2 SAVED
01.17 KWH SAVE L
01.18 KWH SAVE H

GROUP 03

STATUS

03.01 FBUS CW 1
03.03 FBUS SW 1
03.05 FLT WORD 1
03.06 FLT WORD 2
03.07 FLT WORD 3
03.08 WRN WORD 1
03.09 WRN WORD 2

GROUP 04

FAULT LOG

04.01 LAST FAULT
04.02 F1 TIME 1
04.03 F1 TIME 2
04.04 F1 VOLTAGE
04.05 F1 CURRENT
04.06 F1 EVENT 1
04.07 F1 E1 TIME
04.08 F1 EVENT 2
04.09 F1 E2 TIME
04.10 FAULT 2
04.11 F2 TIME 1
04.12 F2 TIME 2
04.13 F2 VOLTAGE
04.14 F2 CURRENT
04.15 F2 EVENT 1
04.16 F2 E1 TIME
04.17 F2 EVENT 2
04.18 F2 E2 TIME
04.19 FAULT 3
04.20 FAULT 4
04.21 FAULT 5

GROUP 05

EVENT LOG

05.01 LAST EVENT
05.02 E1 TIME 1
05.03 E1 TIME 2
05.04 EVENT 2
05.05 E2 TIME 1
05.06 E2 TIME 2
05.07 EVENT 3
05.08 E3 TIME 1
05.09 E3 TIME 2
05.10 EVENT 4
05.11 E4 TIME 1
05.12 E4 TIME 2

GROUP 14

RELAY OUT

14.01 RO1 SELECT
14.02 R1 ON DLY
14.03 R1 OFF DLY
14.04 RO2 SELECT
14.05 R2 ON DLY
14.06 R2 OFF DLY
14.07 RO3 SELECT
14.08 R3 ON DLY
14.09 R3 OFF DLY
14.10 RO4 SELECT
14.11 R4 ON DLY
14.12 R4 OFF DLY
14.13 RO5 SELECT
14.14 R5 ON DLY
14.15 R5 OFF DLY

GROUP 16

SYSTEM CTRL

16.01 START/STOP
16.02 PERMISSIVE
16.03 INTERLOCK 1

16.04 INTERLOCK 2

16.05 INTERLOCK 3

16.06 INTERLOCK 4

16.07 RESET SRC

16.08 AUTO XFR

16.09 OC TRANSFR

16.10 OV TRANSFR

16.11 UV TRANSFR

16.12 AI TRANSFR

16.13 BP DISABLE

16.14 BP RUN DLY

16.15 SAVE PARAM

16.16 DISP ALRMS

16.17 DRIVE TEST

16.18 PASS CODE

16.19 PAR LOCK

16.20 PERMIS TXT

16.21 INTLK1 TXT

16.22 INTLK2 TXT

16.23 INTLK3 TXT

16.24 INTLK4 TXT

16.25 COMM CTRL

16.26 MODE LOCK

16.27 COST/KWH

16.28 LEARN MODE

16.29 LEARN TIME

16.30 REVERSE REQ

16.31 DRV/BYPASS

16.40 PASS SET

16.41 PASS CNFRM

16.42 ABB ACCESS

16.43 FB LOCK

16.44 DNLD LOCK

GROUP 17

VERRIDE 2

17.01 OVERRIDE 2

17.02 PERMIS OVR

17.03 INTLK1 OVR

17.04 INTLK2 OVR

17.06 INTLK4 OVR

17.07 FAULTS OVR

17.08 OVRD2 MODE

GROUP 30

FLT FUNCTION

30.01 UL ACTION

30.02 UL TIME

30.03 UL TRIP %

30.04 COMM LOSS

30.05 COMM TIME

30.06 PHASE LOSS

30.07 PHASE SEQ

GROUP 32

SUPERV CTRL

32.01 SUPER CTRL

32.02 START LVL

32.03 STOP LEVEL

32.04 START DLY

32.05 STOP DLY

32.06 FBK LOSS

GROUP 33

INFORMATION

33.01 FW VERSION

33.02 PT VERSION

33.03 LP VERSION

33.04 CB VERSION

33.05 TEST DATE

33.06 DRIVE TYPE

33.07 SUB ASMBLY

33.08 PLANT CODE

33.09 MFG DATE

33.10 UNIT NUM

GROUP 50

BYPASS EFB

50.03 BP MAC ID

50.13 TOKEN CNT

50.40 BP OB ID L

50.99 BP OB ID H

GROUP 51

EXT COMM MOD

51.01 FBA TYPE

51.02 FBA PAR 2

51.03 FBA PAR 3

51.04 FBA PAR 4

51.05 FBA PAR 5

51.06 FBA PAR 6

51.07 FBA PAR 7

51.08 FBA PAR 8

51.09 FBA PAR 9

51.10 FBA PAR 10

51.11 FBA PAR 11

51.12 FBA PAR 12

51.13 FBA PAR 13

51.14 FBA PAR 14

51.15 FBA PAR 15

51.16 FBA PAR 16

51.17 FBA PAR 17

51.18 FBA PAR 18

51.19 FBA PAR 19

51.20 FBA PAR 20

51.21 FBA PAR 21

51.22 FBA PAR 22

51.23 FBA PAR 23

51.24 FBA PAR 24

51.25 FBA PAR 25

51.26 FBA PAR 26

51.27 REFRESH

51.28 FBA PAR 28

51.29 FBA PAR 29

51.30 FBA PAR 30

51.31 FBA STATUS

51.32 FBA PAR 32

51.33 FBA PAR 33

GROUP 52

FBA DATA IN

52.01 DATA IN 1

52.02 DATA IN 2

52.03 DATA IN 3

52.04 DATA IN 4

52.05 DATA IN 5

52.06 DATA IN 6

52.07 DATA IN 7

52.08 DATA IN 8

52.09 DATA IN 9

52.10 DATA IN 10

GROUP 53

FBA DATA OUT

53.01 DATA OUT 1

53.02 DATA OUT 2

53.03 DATA OUT 3

53.04 DATA OUT 4

53.05 DATA OUT 5

53.06 DATA OUT 6

53.07 DATA OUT 7

53.08 DATA OUT 8

53.09 DATA OUT 9

53.10 DATA OUT 10

GROUP 58

DRIVE EFB

58.02 DV PROT ID

58.03 DV MAC ID

58.04 BAUD RATE

58.05 EFB PARITY

58.07 DV STATUS

58.08 DV OK MSG

58.11 UART ERROR

58.12 DV CRC ERR

58.13 TOKEN CNT

58.17 TX DELAY

58.18 EFB CNTRL

58.19 EFB STAT

58.25 PROFILE

58.40 DV OB ID L

58.41 MAX MASTER

58.42 MAX INF FR

58.99 DV OB ID H

58.100 DB REV

58.105 DV IO 5

58.106 DV IO 6

58.107 DV IO 7

58.108 DV IO 8

58.109 DV IO 9

58.110 DV IO 10

58.111 DV IO 11

58.112 DV IO 12

GROUP 98

OPTIONS

98.02 COMM PROT SEL

GROUP 99

STARTUP DATA

99.02 B.P. MACRO



3AXD50000049127D



3AXD50000049127 REV D
Effective: 2018-08-15
Supersedes: 2018-06-08

